



happybeds

ASSEMBLY INSTRUCTIONS **MARQUIS FABRIC 6' OTTOMAN BED**

IMPORTANT: READ THESE INSTRUCTIONS CAREFULLY BEFORE ATTEMPTING TO ASSEMBLE OR USE YOUR MARQUIS FABRIC 6' OTTOMAN BED.

PLEASE KEEP THESE INSTRUCTIONS FOR FUTURE REFERENCE.

HEALTH & SAFETY:

DO NOT jump on this bed frame.

DO NOT use this bed frame if any parts are missing, damaged or worn.

DO NOT use this bed frame unless all fixings are tightly secured.

Always use on a level, even surface.

WARNING: IF THIS BED FRAME IS ON A LAMINATED FLOOR YOU MUST PLACE SOME PROTECTION UNDER ALL LEGS TO STOP THE BED FRAME FROM MOVING. IF THIS IS NOT ADHERED TO THERE IS NO GUARANTEE IF THE BED FRAME COLLAPSES.

WARNING: Take care when assembling the base, assemble the ottoman as close to its final position. The Ottoman has a powerful mechanism and after assembly should only be opened when the mattress is in place.

CARE & MAINTENANCE:

Periodically check all screws & fixings to ensure they are tightly secured.

DO NOT push the bed frame as this will damage the legs.





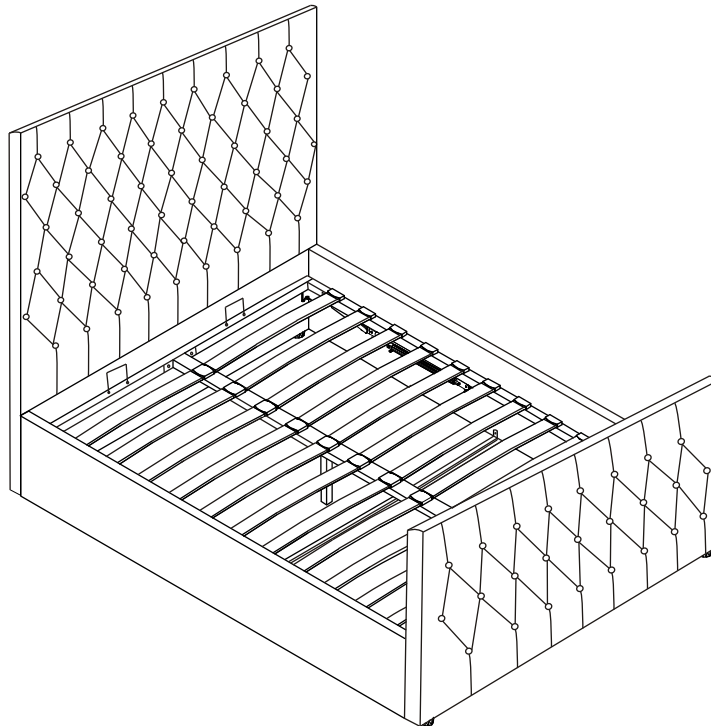







Always lift the bed with 2 people whenever you need to change the bed frames position.

Keep any sharp objects away from the bed frame.



PARTS LIST

HARDWARE LIST (Found in box3)





No	Item	Box	Qty	No	Item	Qty
1	Wooden Block	3	1	A	M5 Allen Key 	1
2	Footboard	3	1	B	Bolts (M8x30mm) 	8
3	Headboard	1	1	C	Spring Washer (M8) 	8
4	Side Rails	2	2	D	Flat Washer (M8x22mm) 	8
5	Cross support bar	3	2	E	Nuts (8x13) 	12
6	Cross Bar	3	1	F	Spanner (8x13) 	1
7	Corner Bracket	3	4	G	Bolts (M6x15mm) 	10
8	Centre support bar	2	1	H	Bolts (M8x45mm) 	10
9	Slats	3	28	I	M4 Allen Key 	1
10	Support Leg	3	1	J	Bolts (M8x15mm) 	4
11	Metal Hook	3	2	K	Bolts (M8x70mm) 	4
12	Pull Strap	3	1	L	Single Plastic caps 	28
13	Woven Fabric	3	1	M	Double Plastic caps 	14
14	Front frame rail	3	1			
15	Back frame rail	3	1			
16	Left frame rail	2	1			
17	Right frame rail	2	1			

Step 1:

To fix the side rails(4) to the headboard(3) and footboard(2) you will need to use hardware parts B,C and D with the M5 allen key(A).

To fix the wooden block(1) to the footboard(2) you will need to use hardware parts H with the M5 allen key(A).

DO NOT use any power tools as this may damage the bed frame and will invalidate any claims.

A	 M5 Allen Key (1pc)
B	 Bolts (M8x30mm) (8 pcs)
C	 Spring Washer (M8) (8 pcs)
D	 Flat Washer (M8x22mm) (8 pcs)
H	 Bolts (M8x45mm) (2 pcs)

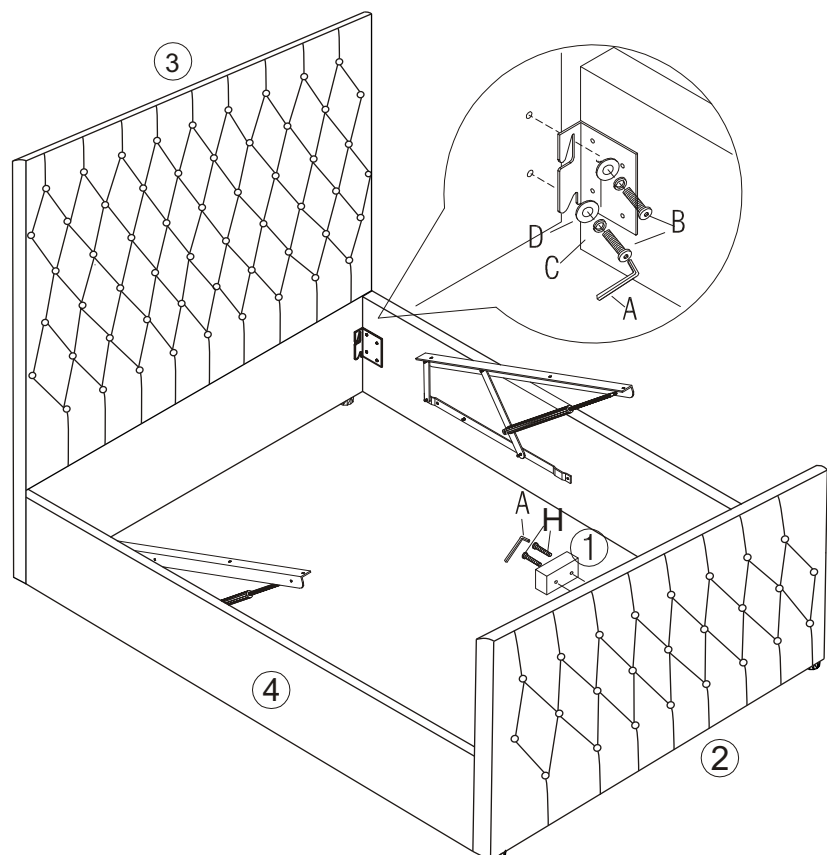



Step 2:

To attach the corner bracket (7) to the headboard (3), footboard (2) and side rails (4) you will need to use hardware parts G and the M4 allen key (I).

To fix the cross bar (6) to the side rails, you will need to use hardware parts G and the M4 allen key (I).

DO NOT use any power tools as this may damage the bed frame and will invalidate any claims.

G	 Bolts (M6x15mm) (10 pcs)
I	 M4 Allen Key (1 pc)

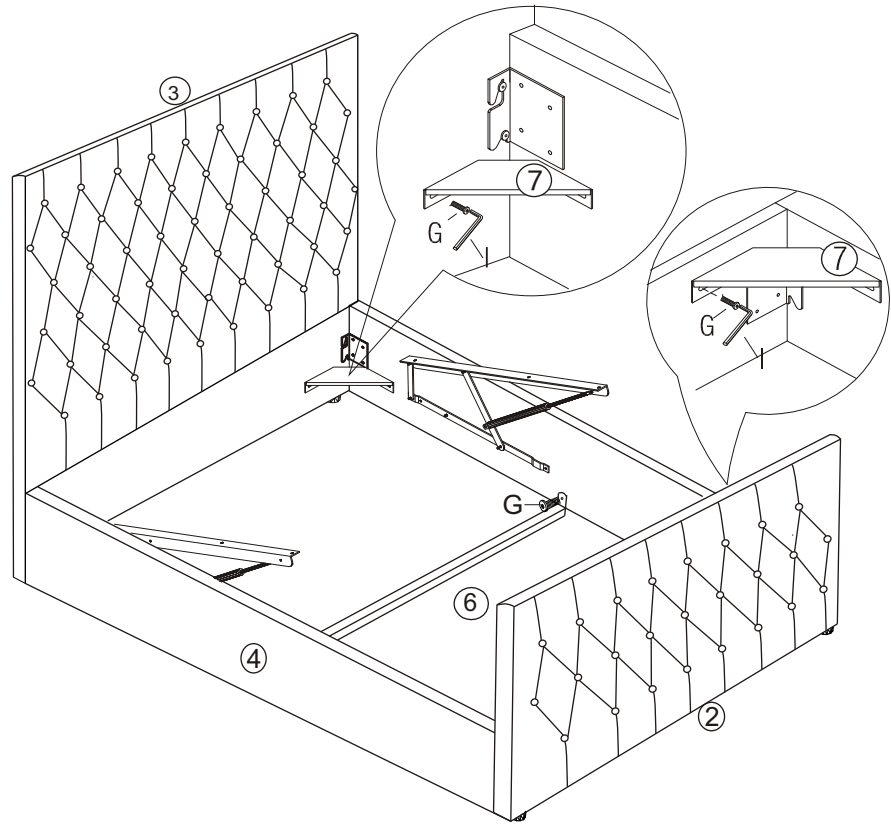

Step 3:

To attach the front frame rail (14) and back frame rail (15) to the left frame rail (16) and right frame rail (17), you will need hardware parts J with the M5 allen key (A).





To attach the centre support bar (8) to the front frame rail (14) and back frame rail (15), you will need hardware parts H and E with the M5 allen key (A) and the spanner (F).

To attach the support leg (10) to the centre support bar (8), you will need hardware parts H and E with the M5 allen key (A) and the spanner (F).

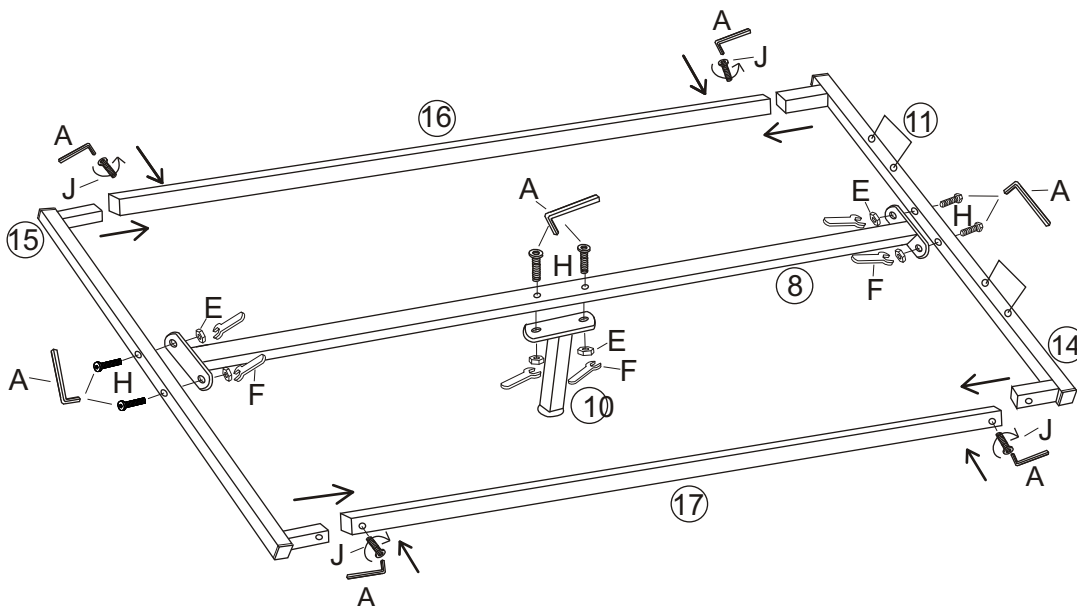
Insert the metal hook (11) to the front frame rail (14).

DO NOT use any power tools, this may damage the bed frame and will invalidate any claims.







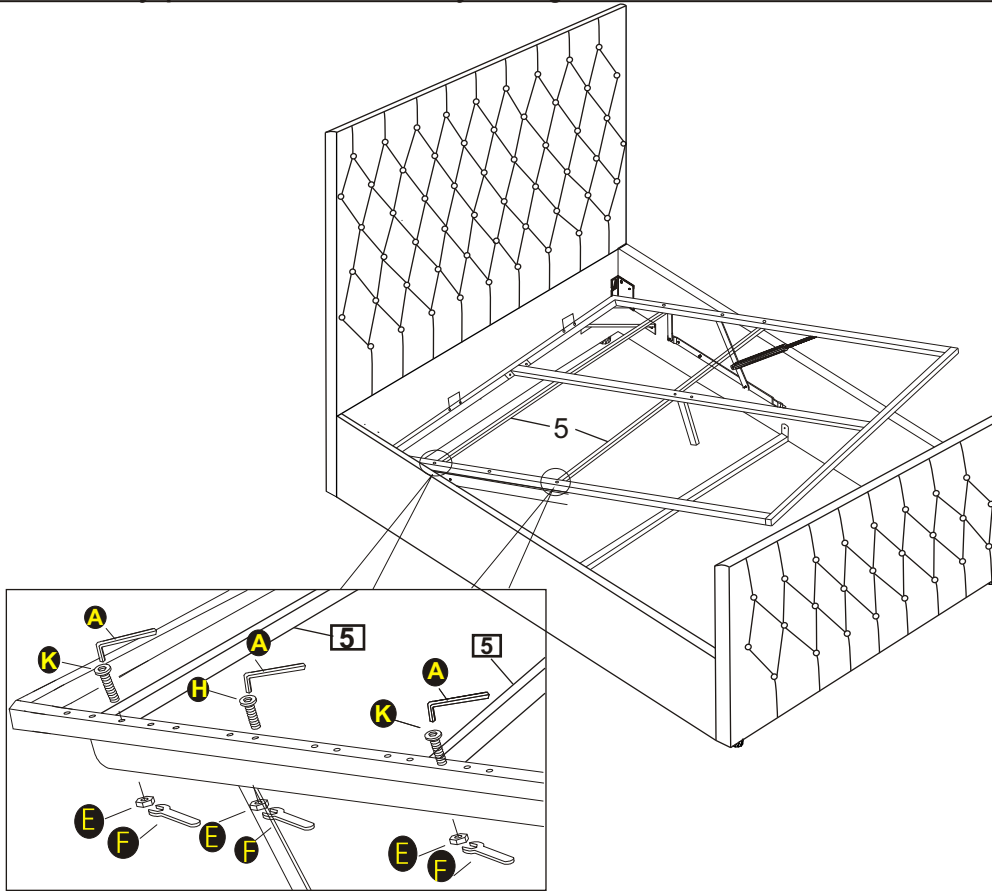

A	 M5 Allen Key (1 pc)
E	 Nuts (8x13) (6 pcs)
F	 Spanner (8x13) (1 pc)
H	 Bolts (M8x45mm) (6 pcs)
J	 Bolts (M8x15mm) (4 pcs)

Step 4:

To attach the metal frame (14/15/16/17) and cross support bar (5) to the gas lift pre-fixed to the side rails, you will need to use hardware parts K, E and H with the M5 allen key (A) and the spanner (F).

DO NOT use any power tools as this may damage the bed frame and will invalidate any claims.



A	 M5 Allen Key (1 pc)
E	 Nuts (8x13) (6 pcs)
F	 Spanner (8x13) (1 pc)
K	 Bolts (M8x70mm) (4 pcs)
H	 Bolts (M8x45mm) (2 pcs)

Step 5:

To attach the pull strap (12) to the back frame rail (15) you will place the pull strap (12) beneath the metal frame and then pull the strap on the inner side of the frame through the strap on the outer side of the frame to form a knot.

To assemble the slats (9) place a single plastic cap (L) onto each end of every slat then you need to push the double slat caps (M) into the metal frame.

Tilt the bedframe on to its side and attach the fabric base (13).

DO NOT use any power tools as this may damage the bed frame and will invalidate any claims.

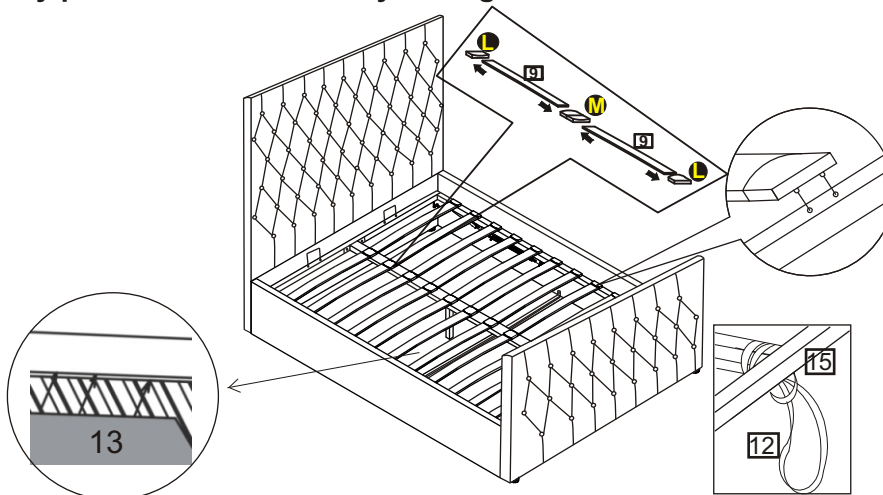

9	Slats (28 pcs)
L	Single Plastic caps (28 pcs)
M	Double Plastic caps (14 pcs)