



Assembly Instructions

PARMA Wooden Bed - 4ft6 Double



Important before assembly:

Read these instructions carefully before assembling or using the product.

Please check the contents of the boxes before attempting to assemble this product. The instructions will have a checklist of parts and fittings.

It would be sensible to lay a rug or a carpet on the floor where you intend to assemble the product, to avoid scratches and damaging the product or the floor.

Assemble the product as close to its intended final location/room as possible.

Do NOT use any power tools as this may damage the frame.

Health & Safety:

This product or some parts of this product will be heavy. Please use an assistant when lifting.

Please keep small parts out of reach of children.

Always use on a level, even surface.

DO NOT jump on the product or any of its parts.

DO NOT use this product if any parts are missing, damaged or worn.

DO NOT use this product unless all fixings are secured.

Please keep these instructions for future reference.



(Not metal)

These tools are not necessary, but may help to assemble certain parts of the product.

Do NOT use any power tools as this may damage the frame.



This product or some parts of this product will be heavy. Please use an assistant when lifting.

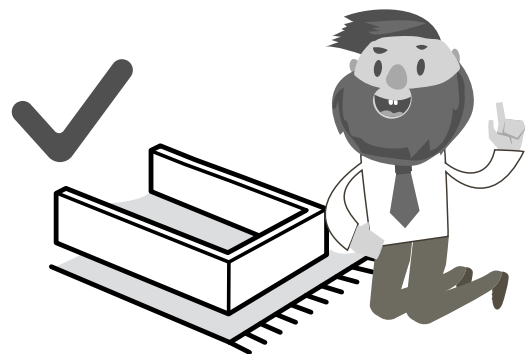

Never drag or push the pieces across a hard or stone floor as this will cause damage to the joints. Use a carpet or a rug for extra care.

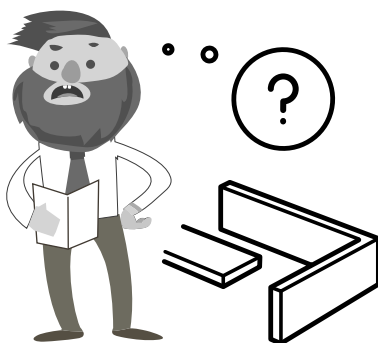

If you have problems assembling or have damaged or missing pieces, please contact us by visiting:

<https://www.happybeds.co.uk/customer-service>

Assembly Instructions Parma Twin & Double Bed

Part in Box 1

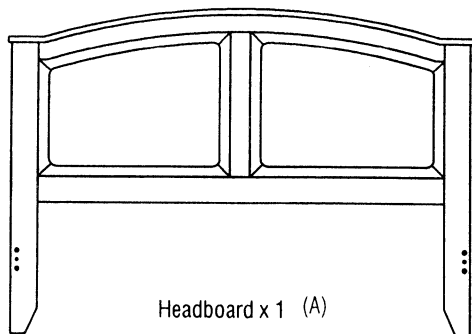

Part in Box 3

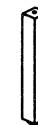
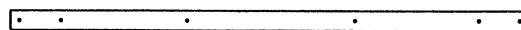
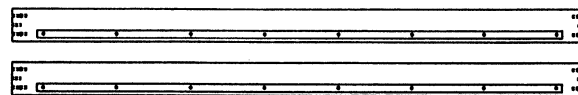

Support Legs x 4

Part in Box 2

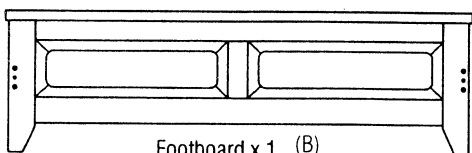

Part in Box 4

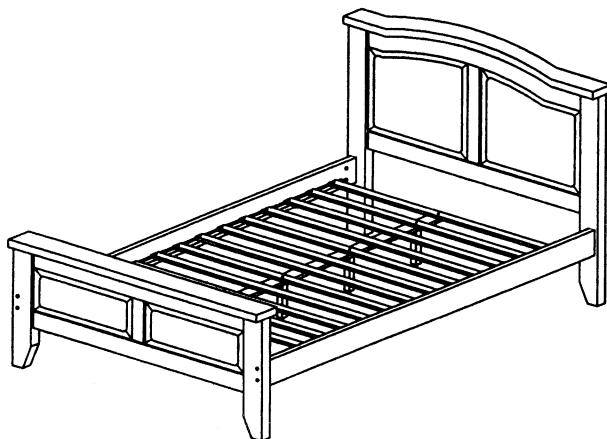
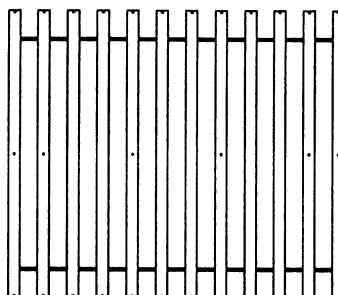

ASSEMBLY TIPS

Remove hardware from box and sort by size to check that all hardware and parts are present before assembling. Follow instructions below in the proper sequence to ensure fast, easy and correct assembly.

WARNING !!

DO NOT FULLY TIGHTEN ALL BOLTS UNTIL ALL PARTS ARE IN PLACE. FAILURE TO FOLLOW THIS INSTRUCTION MAY CAUSE THE BOLTS TO BE MISALIGNED DURING THE ASSEMBLY.

NOTE : DURING ASSEMBLY , DO NOT TIGHTEN ANY SCREWS UNTIL THE COMPLETE UNIT HAS BEEN ASSEMBLED.

Hardware List

1.	JCBC M6 x 70mm		x 8
2.	JCBC M6 x 65mm		x 4
3.	JCBC M6 x 45mm		x 2
4.	M6 x 15mm Barrel Nut		x 8
5.	Wood Dowel M10 x 40mm		x 4
6.	M6 Hex . Nut		x 2
7.	Flat Washer		x 2
8.	CSK M4 x 25mm		x 24
9.	Adjustable Screw		x 4
10.	M4 Allen Key		x 1

Tool required for assembly :



- * Allen Key (supplied)
- * Phillips Screwdriver (not supplied)

Thank you for purchasing this quality product. Be sure to check all packed material carefully for small parts which may have come loose inside the carton during shipment. Place all parts on a clean , smooth surface such as a rug or carpet to avoid scratching the parts. Be sure you have all the parts and hardware before you begin assembly.



Assembly Instructions





Parma Twin & Double Bed

1 Attach the Side Rails (C) to the Headboard (A) and Footboard (B).

1.	JCBC M6 x 70mm		x 8
4.	M6 x 15mm Barrel Nut		x 8
5.	Wood Dowel M10 x 40mm		x 4

2 Lock the Support Legs (E) on Slats (F) & Center Rail (D). Please Note that the Hex Nut or Support Legs (E) have Adjuster at Bottom. Unscrew to Adjust if necessary.
Fit the Slats (F) in the Place.

8.	CSK Screw M4 x 25mm		x 24
9.	Adjustable Screw		x 4

2.	JCBC M6 x 65mm		x 4
3.	JCBC M6 x 45mm		x 2
6.	M6 Hex . Nut		x 2
7.	Flat Washer		x 2

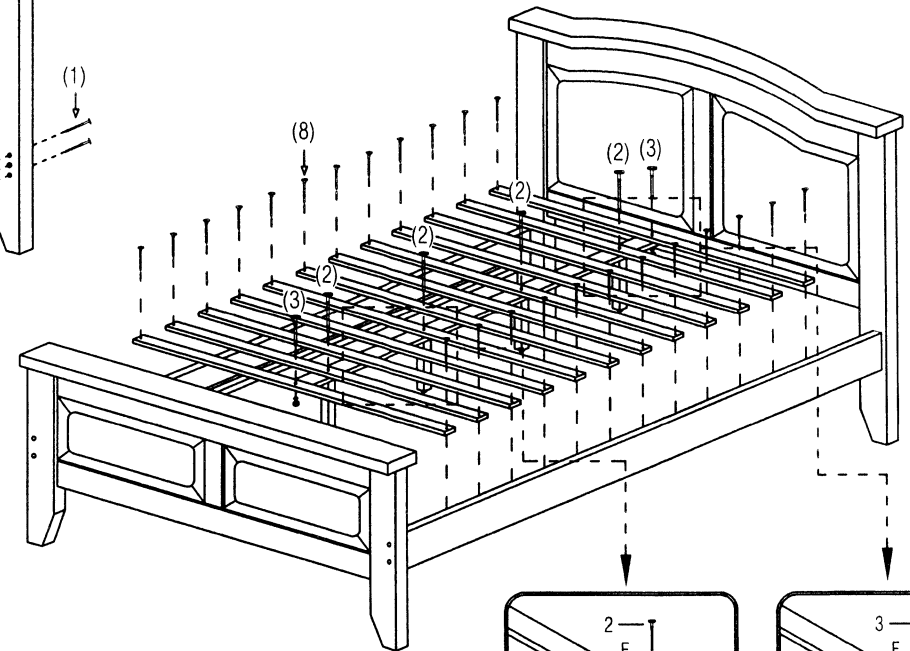
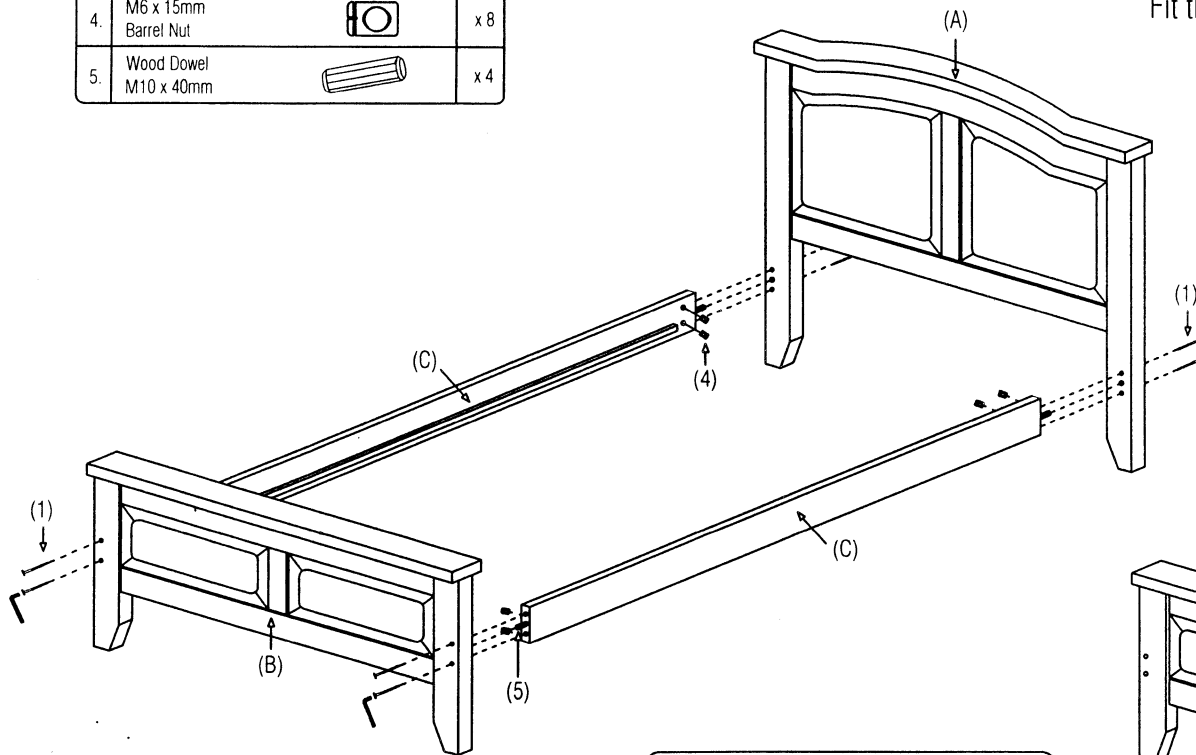

Tighten the Bolts.
When everything is put together tighten all the Bolts.

Lay the Slats inside the Side Rails as shown below, and fix in place with 25mm Csk Screws (total 24)

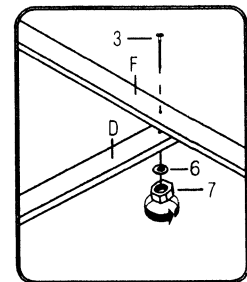
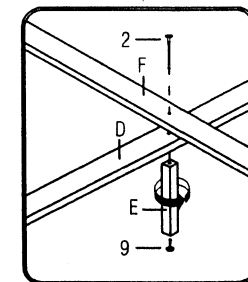

Please dispose of all packaging safely.

General Care & Maintenance

Wipe clean with a slightly damp cloth.
Avoid the use of all household cleaners and abrasives.

Periodically check all screw & fixings to ensure they are secure.
When moving your product, carefully lift into place. Never drag or push the pieces across the floor as this will cause damage to the joints and could result in failure to the product that will invalidate the warranty.

For more information on cleaning and product care visit:
<https://www.happybeds.co.uk/help-and-advice>

Notes

We've tried to make this product as easy to assemble as possible. In the unlikely event that you have problems putting it together or have damaged or missing pieces, please contact us by visiting:

<https://www.happybeds.co.uk/customer-service>



www.happybeds.co.uk

