

Assembly Instructions

Important before assembly:

Read these instructions carefully before assembling or using the product.

Please check the contents of the boxes before attempting to assemble this product. The instructions will have a checklist of parts and fittings.

Assemble the product as close to its intended final location/room as possible.

Health & Safety:

This product or some parts of this product will be heavy. Please use an assistant when lifting.

Please keep small parts out of reach of children.

Always use on a level, even surface.

DO NOT jump on the product or any of its parts.

DO NOT use this product if any parts are missing, damaged or worn.

DO NOT use this product unless all fixings are secured.

Further instructions are on the following pages.

Please keep these instructions for future reference.

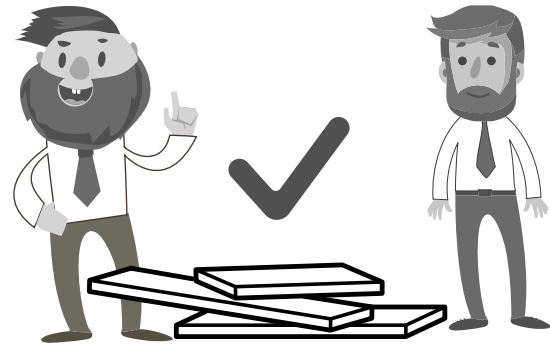
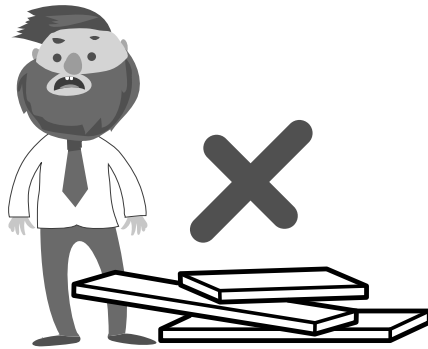



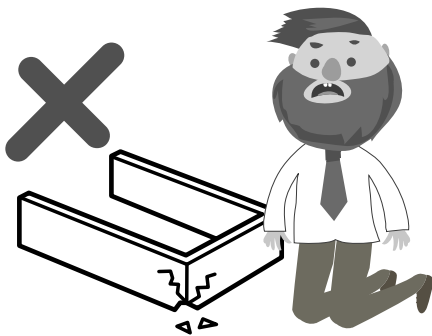



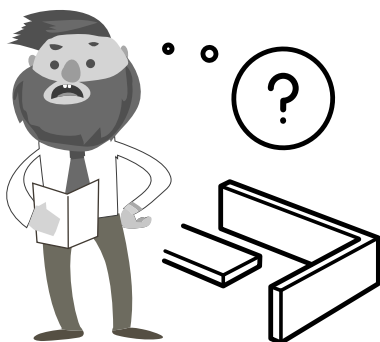

This product or some parts of this product will be heavy. Please use an assistant when lifting.











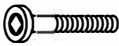

Never drag or push the pieces across a hard or stone floor as this will cause damage to the joints. Use a carpet or a rug for extra care.

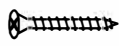

If you have problems assembling or have damaged or missing pieces, please contact our customer services (details at the back of these instructions)

Parts List				
Parts	Description		Box	Qty
1	Headend		1	1
2	Footend		2	1
3	Side Rail		2	2
4	Legs		2	4
5	Slat		2	28
6	Centre Rail		2	1
7	Support Leg		2	2
8	Side Wing		1	2

Hardware List (Found in box 2)				
Parts	Description		Box	Qty
A	M6 x 40 mm JCBC		2	2
B	M6 x 50 mm JCBC		2	8
C	Allen Key M4 x 100 mm		2	1
D	Allen Key M5 x 70 mm		2	1
E	M4 x 25 mm CSK		2	2
F	Double Slat Cap		2	14
G	Single Slat Cap		2	28
H	Adjuster		2	2
I	Flat Washers		2	4
J	M8 x 20 mm JCBB		2	8

*You will need a screwdriver (not provided)

Alina

Assembly instructions



Step 1: Attach the legs (4) to the headend (1) and footend (2). Attach the side wing (8) to the headend (1).
DO NOT use any power tools as this may damage the frame and will invalidate any claim.

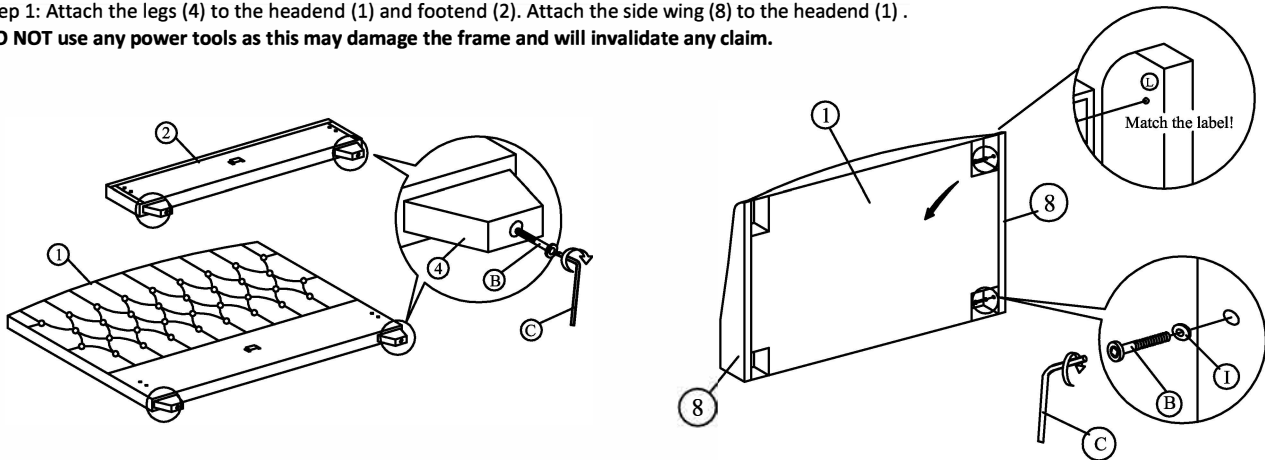

Step 2: Attach the side rails (3) by pushing the brackets down into place as shown.
DO NOT use any power tools as this may damage the frame and will invalidate any claim.

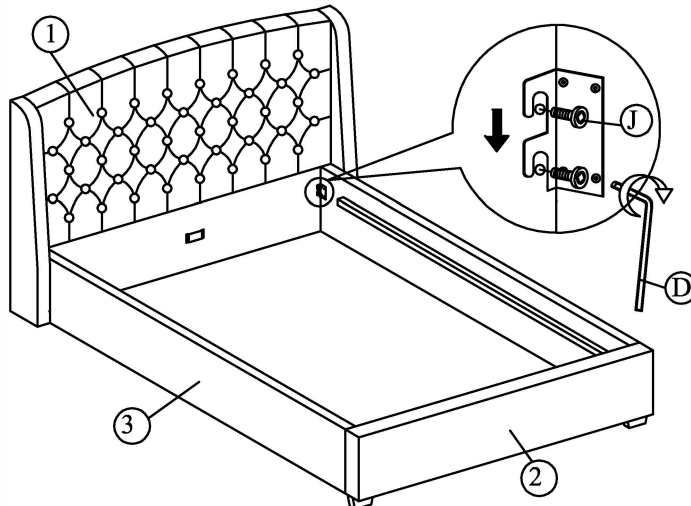

Step 3: Attach the support legs (7) to the centre rail (6) using hardware parts A and B.
DO NOT use any power tools as this may damage the frame and will invalidate any claim.

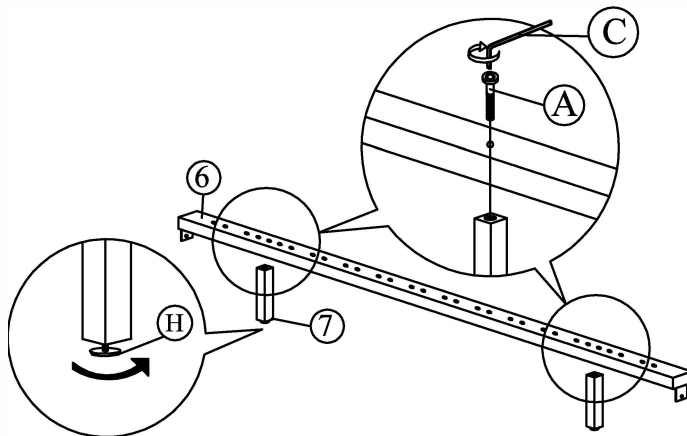

Step 4: Insert the centre rail (6) to the headboard (1) and footboard (2) and secure using hardware part E and a screwdriver (not provided).
DO NOT use any power tools as this may damage the frame and will invalidate any claim.

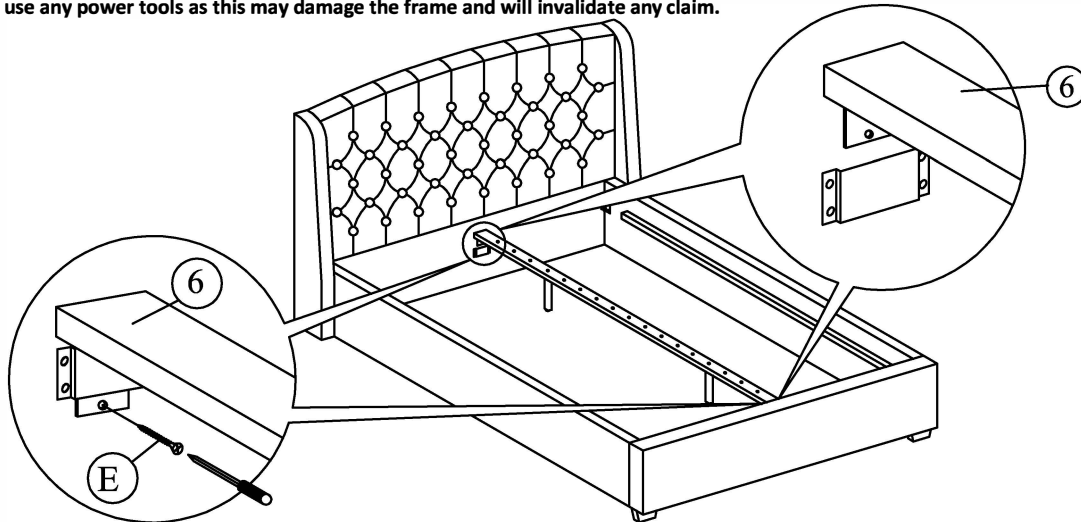

Step 5: Attach the slats (5) using hardware parts F and G then secure the bolts using hardware part D.
DO NOT use any power tools as this may damage the frame and will invalidate any claim.

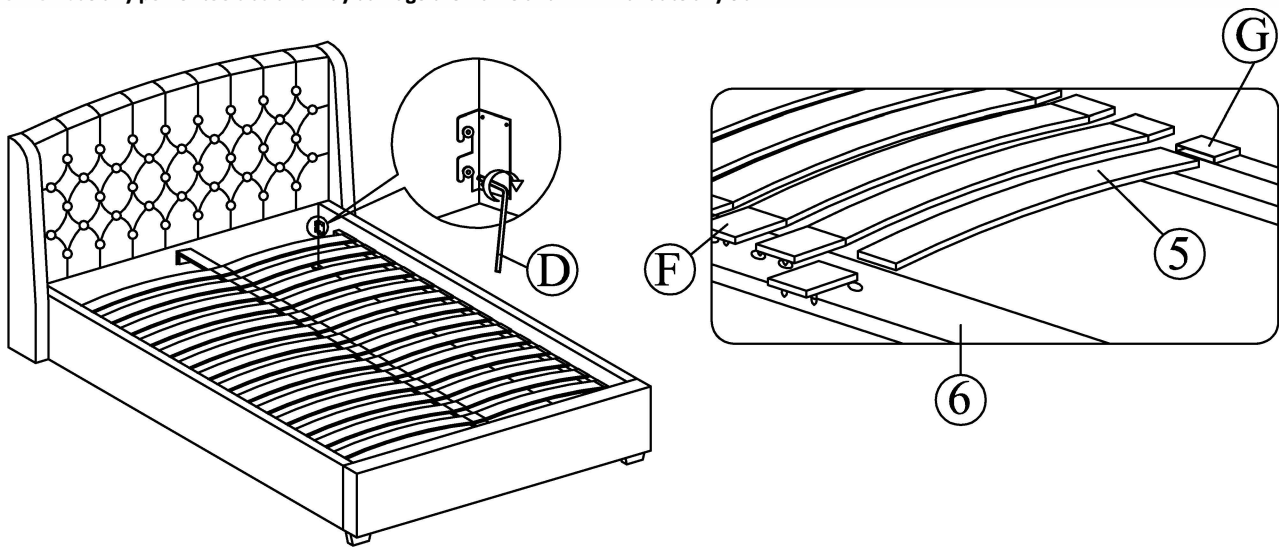

Please dispose of all packaging safely.

General Care & Maintenance

Wipe clean with a slightly damp cloth.
Avoid the use of all household cleaners and abrasives.

Periodically check all screw & fixings to ensure they are secure.

When moving your product, carefully lift into place. Never drag or push the product across the floor as this will cause damage to the joints. If the product is used on hard flooring, such as wood or laminated floor, you must place some protection under the legs to stop the product from moving. If this is not adhered to, it could result in failure to the product that will invalidate the warranty.

For more information on cleaning and product care visit:
<https://www.happybeds.co.uk/help-and-advice>

Notes

In the unlikely event that you have problems putting this product together or have damaged or missing parts, please contact us by visiting:
<https://www.happybeds.co.uk/customer-service>