

Assembly Instructions

Important before assembly:

Read these instructions carefully before assembling or using the product.

Please check the contents of the boxes before attempting to assemble this product. The instructions will have a checklist of parts and fittings.

Assemble the product as close to its intended final location/room as possible.

Health & Safety:

This product or some parts of this product will be heavy. Please use an assistant when lifting.

Please keep small parts out of reach of children.

Always use on a level, even surface.

DO NOT jump on the product or any of its parts.

DO NOT use this product if any parts are missing, damaged or worn.

DO NOT use this product unless all fixings are secured.

Further instructions are on the following pages.

Please keep these instructions for future reference.



This product or some parts of this product will be heavy. Please use an assistant when lifting.



Never drag or push the pieces across a hard or stone floor as this will cause damage to the joints. Use a carpet or a rug for extra care.



If you have problems assembling or have damaged or missing pieces, please contact our customer services (details at the back of these instructions)









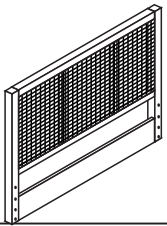
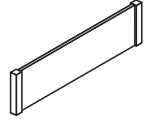
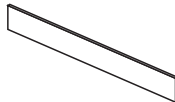
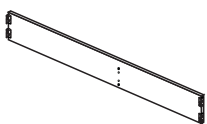
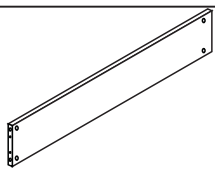

Important for Ottoman and other gas lift beds







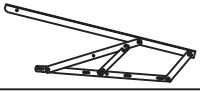
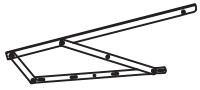





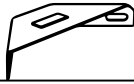





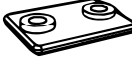

Please follow these final steps to ensure the best experience with your new bed

- Please ensure the pistons are fitted to the bed frame.
- Please place the mattress on top of the bed frame.
- Standing at the foot of the frame (looking at the headboard) open the base and the press quite forcefully down on the mattress - please do not attempt to do this without the mattress being in place.
- Please do not pull on the strap handles.
- Please note as the pistons are full of gas - you will need to press heavily to release the compressed gas.
- Once done the pistons should start operating as normal.

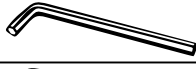

Parts List

Parts	Description	Qty	Box
1	Headboard Frame 	1	1/3
2	Footboard Frame 	1	1/3
3	Left Side Rail 	1	2/3
4	Right Side Rail 	1	
5	Centre Storage Panel 	1	
6	Hydraulic Arm Spacer 	2	
11	Left Side Metal Bar 	1	3/3
12	Right Side Metal Bar 	1	
13	Headboard End Metal Bar 	1	
14	Footboard End Metal Bar 	1	
15	Center Metal Bar 	1	
16	Support Leg 	2	
17	Slat 	30	1/3
18	Left Hydraulic Base Support c/w Pump Stopper 	1	3/3
19	Right Hydraulic Base Support 	1	
20	Hydraulic Base Pump 	2	

Hardware List (Found in box 3)				
Parts	Description		Qty	Box
A	Mini Fix		4	3/3
B	8 x 30 mm Wooden Dowel		4	3/3
C	Metal Corner Block		4	3/3
F	M8 x 20 mm JCBC Bolt		16	3/3
G	M8 x 15 mm JCBC Bolt		16	3/3
H	M8 x 45 mm JCBC Bolt		14	3/3
J	Base Handle		2	3/3
K	M8 Nut		4	3/3
L	Plastic Washer		8	3/3
M	Single Slat Cap		30	3/3
N	Double Slat Cap		15	3/3
P	Belt Handle		1	3/3
Q	Washer Bracket		4	3/3
R	Flat Washer		30	3/3
S	M8 x 40 mm JCBC Bolt		8	3/3
T	M6 Allen Key		1	3/3
U	M8 Allen Key		1	3/3
V	M12.8 Spanner		1	3/3
W	Washer Bracket		6	3/3
X	Spring Washer		30	3/3
Y	Sticker		4	3/3

** You will also need a screwdriver and small mallet (not provided).

Step 1: Firstly, fix the hydraulic pump to each hydraulic base as shown in diagram 1.1. Next fix the left and right hydraulic spacer together with the hydraulic base supports on to both side rails using bolts H. **Ensure Plastic washers (part L) are used between the Hydraulic spacer (part 6) and the hydraulic base support (parts 18/19) as shown in the image.**

Then screw the minifit part A to both side rails as shown in diagram 1.2.

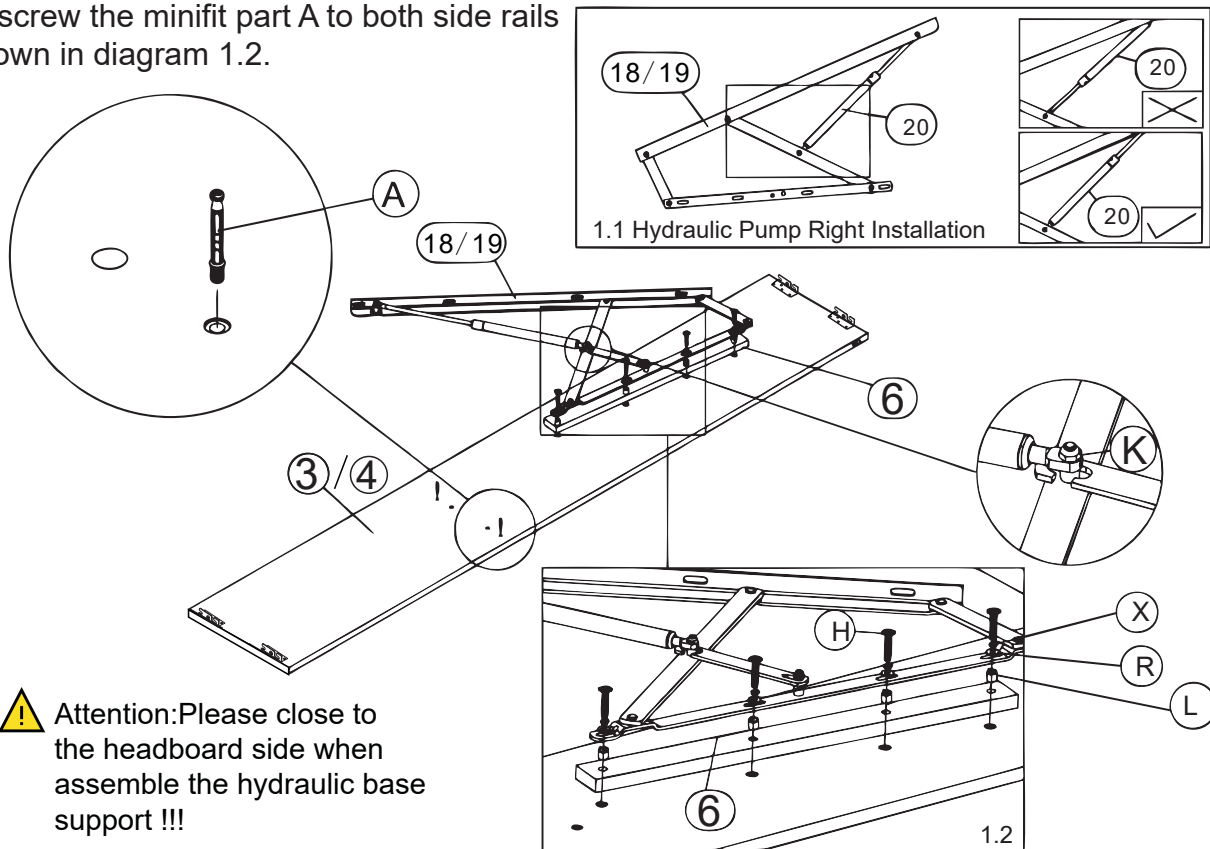

Step 2: Join together the left side rail (3) and right side rail (4) with the centre storage panel (5) using hardware parts A, B and Y.

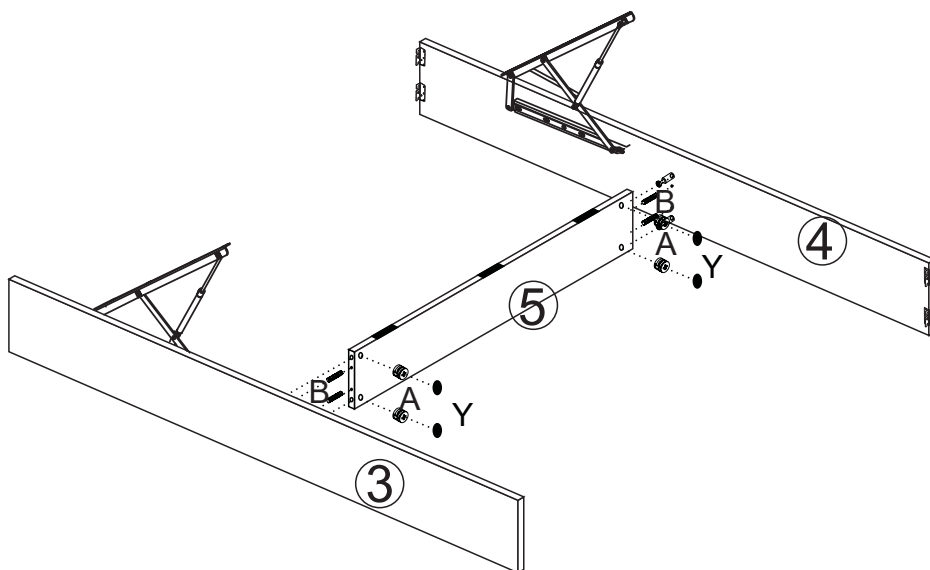

Step 3: Fix the Headboard(1) and Footboard(2) with the bed frame by Hardware(F).

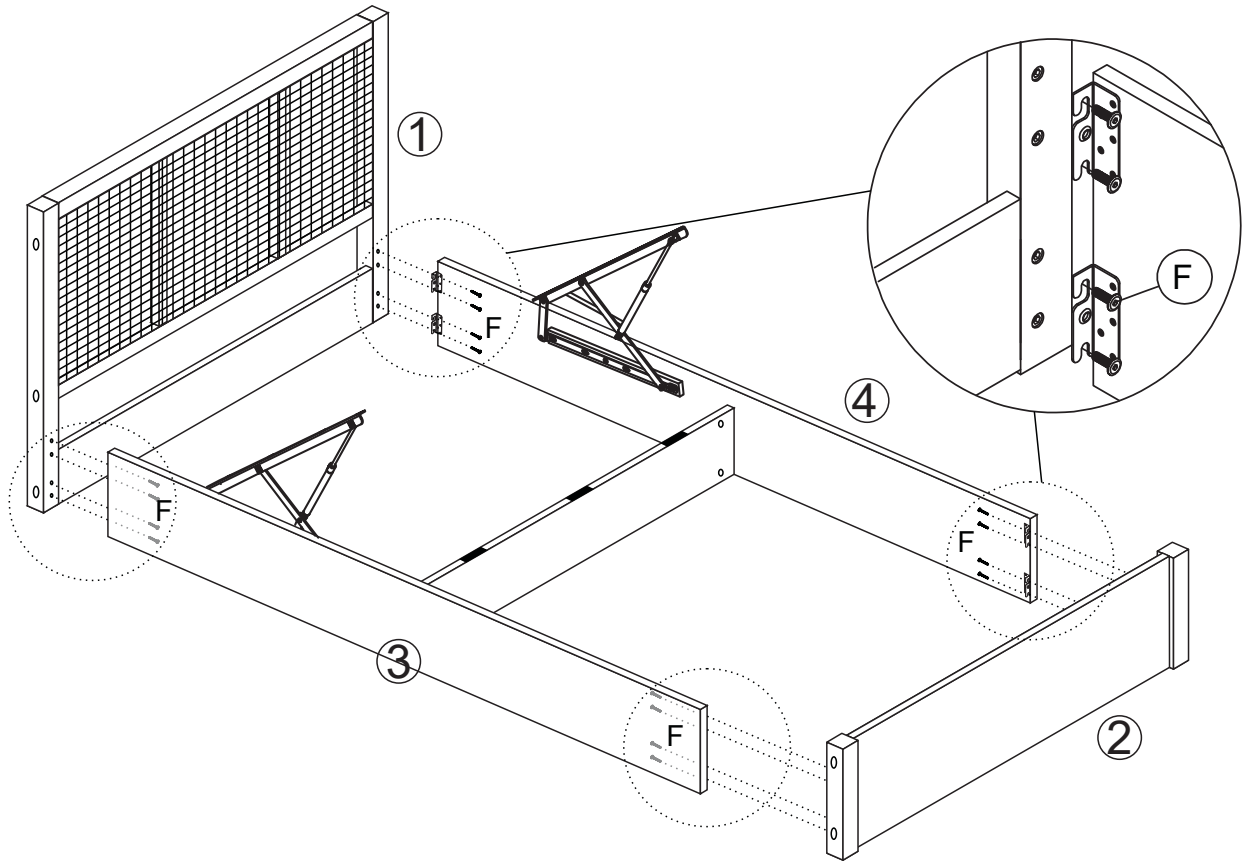

Step 4: Fix the Metal Corner Block(C) by Hardware(G).

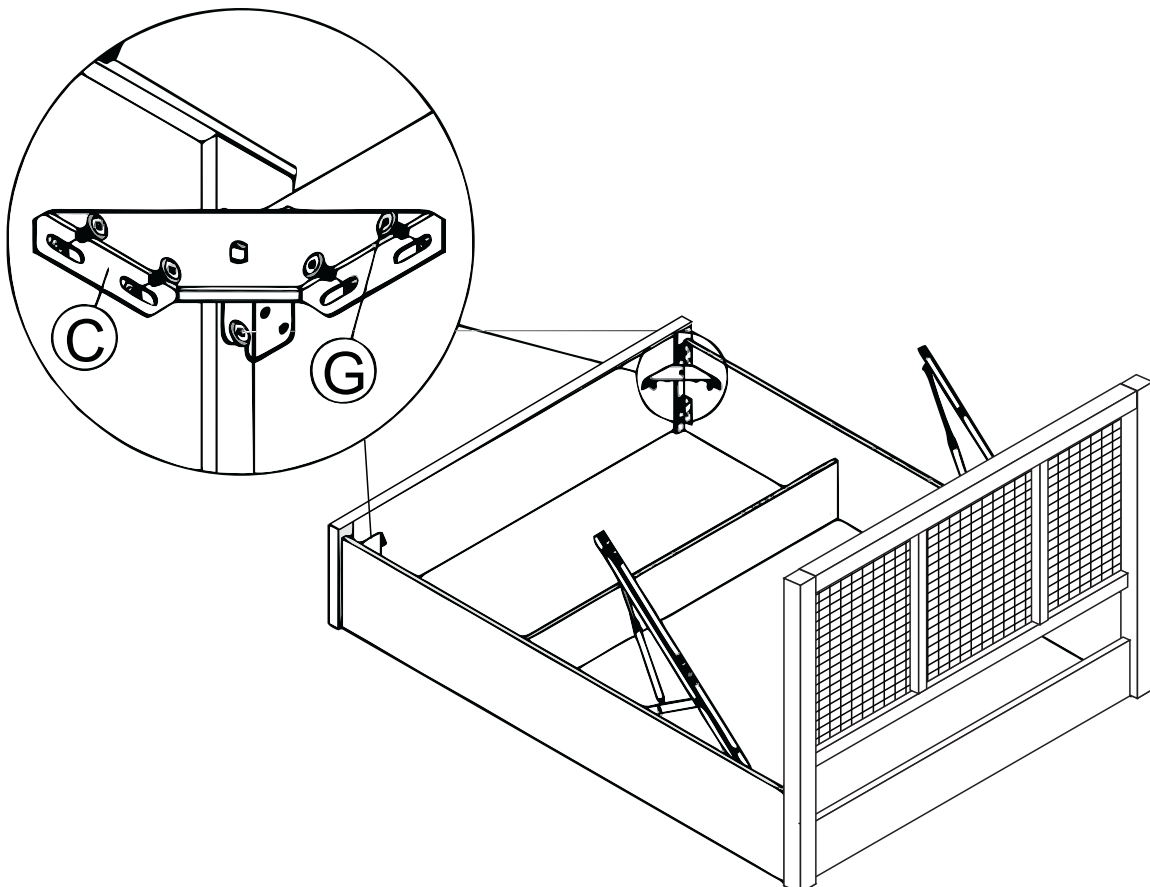

Step 5: Join together all the bed base parts (11),(12),(13) and (14) using hardware parts S,X & R and also slide part P onto Part 14 before bolting together. Attach the centre rail(15) with Metal Frame by hardware G,X&R.And then attach hardware parts J as shown.

Important note:
Please assemble
follow arrow direction.

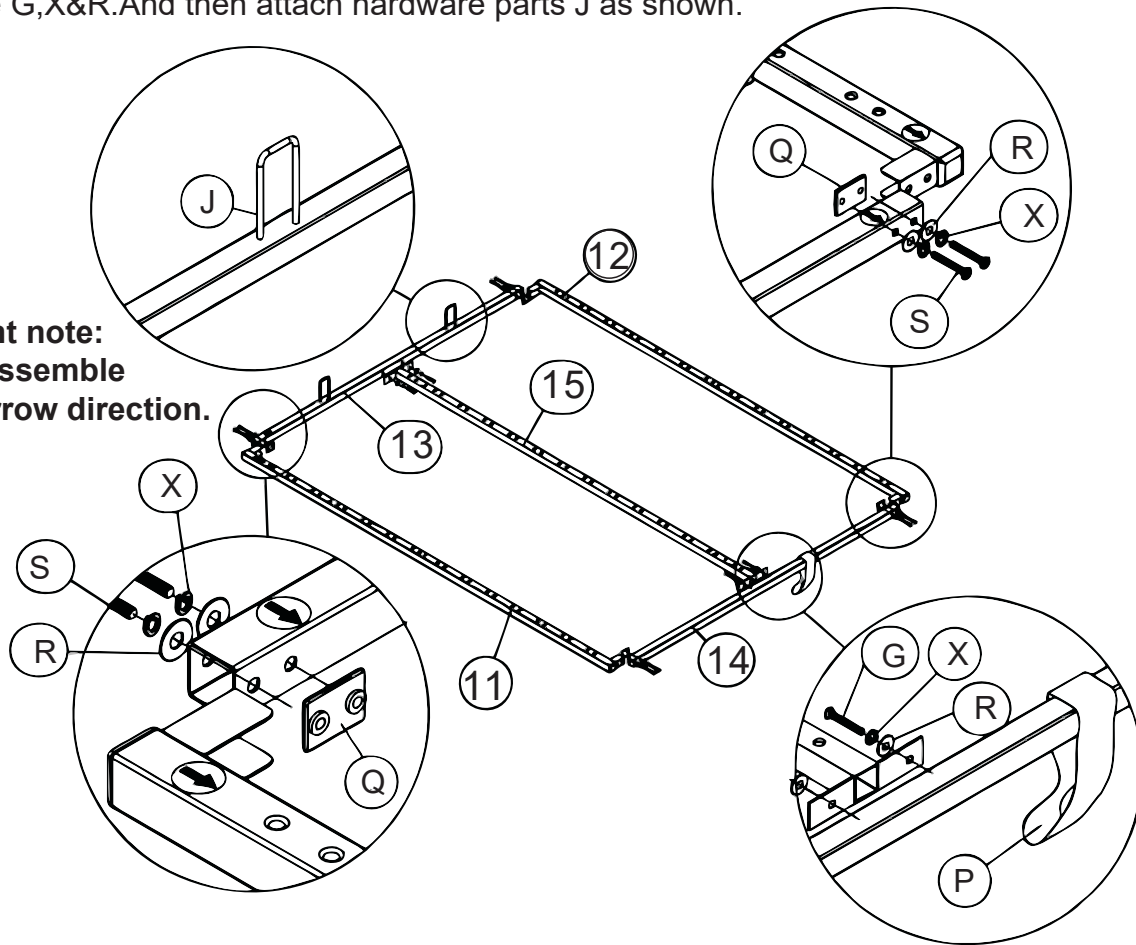

Step 6: Insert the slats (17) to hardware parts M and N then press into the base making sure they are secure.

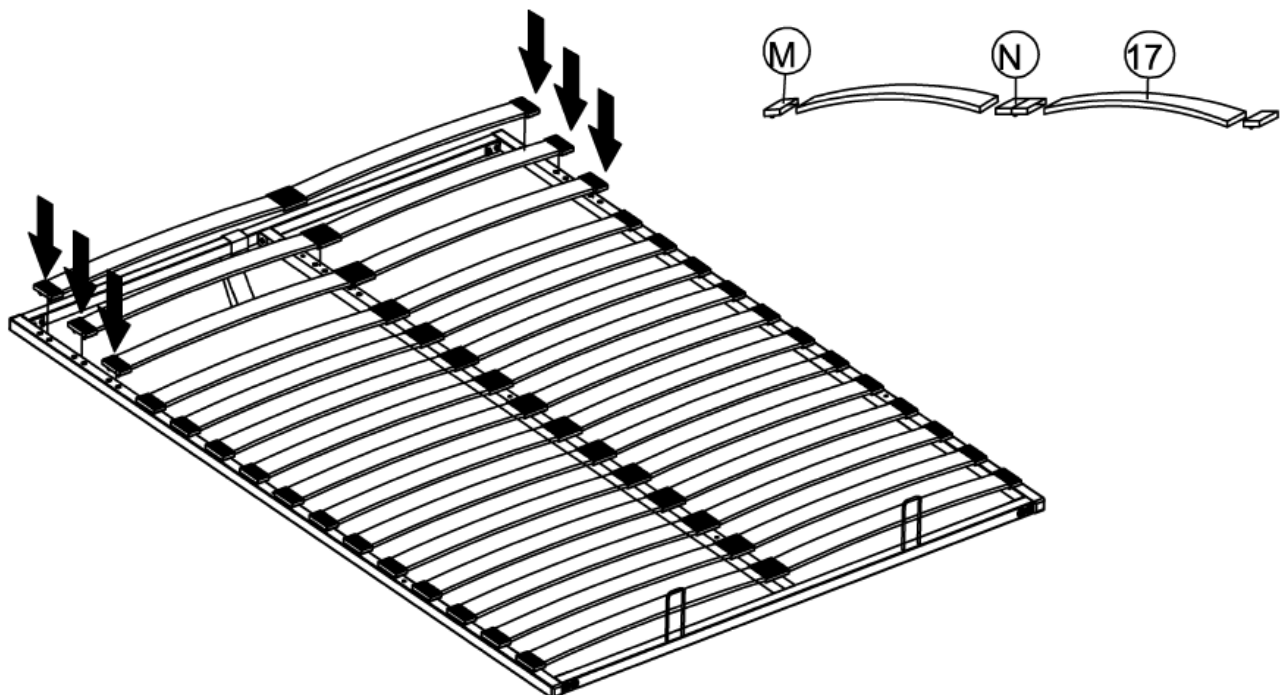

Step 7: Assemble the bed base on the right & left hydraulic frame starting from '1' to '3' as shown with Hardware H, X, R & W, and fix the support leg (16) to the bed base by Hardware G, X & R as shown .

Important note: Do not tighten the bolts yet!, and this assemble must be done by two persons.

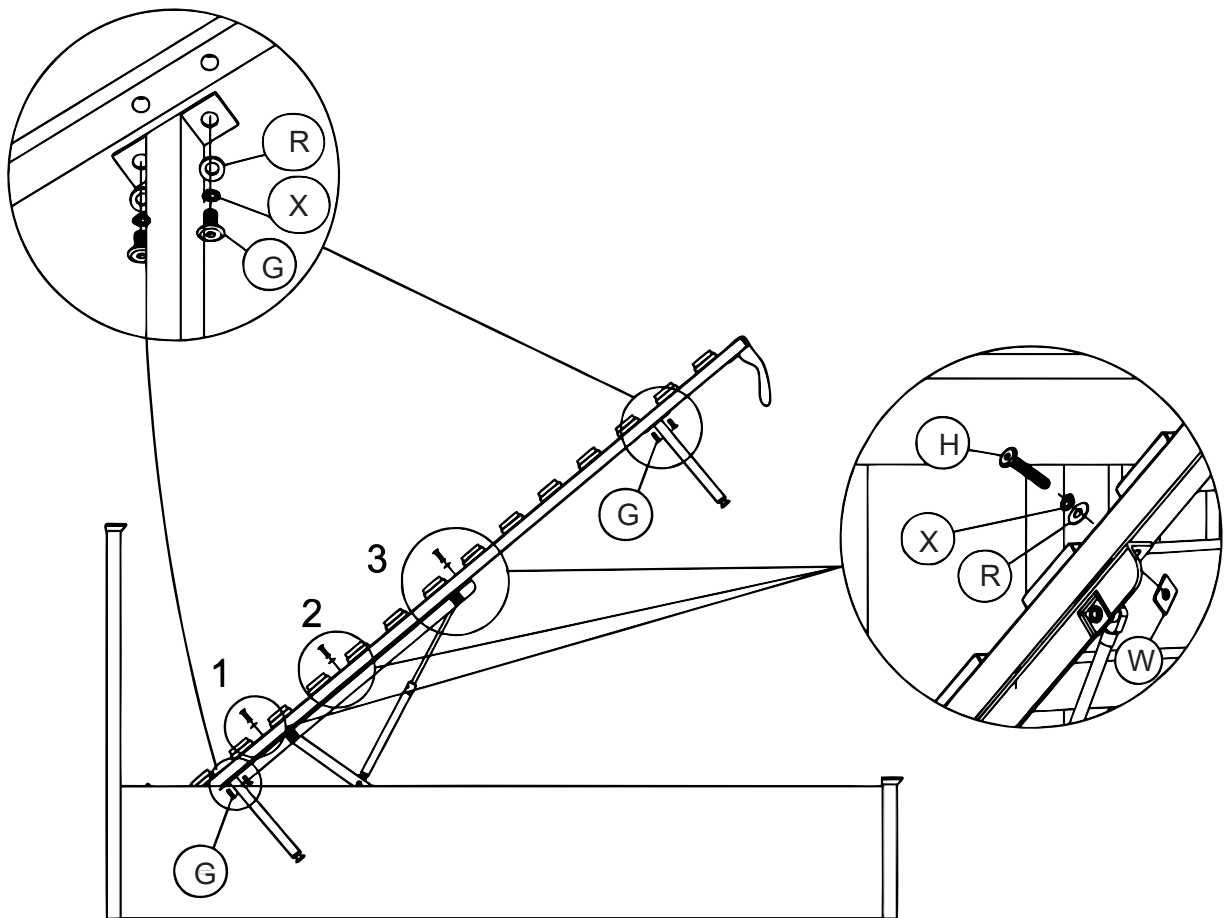

Step 8: Adjust the bed base making sure that the distance to the footboard is approximately 15mm to above . Tighten all bolts and screws now.

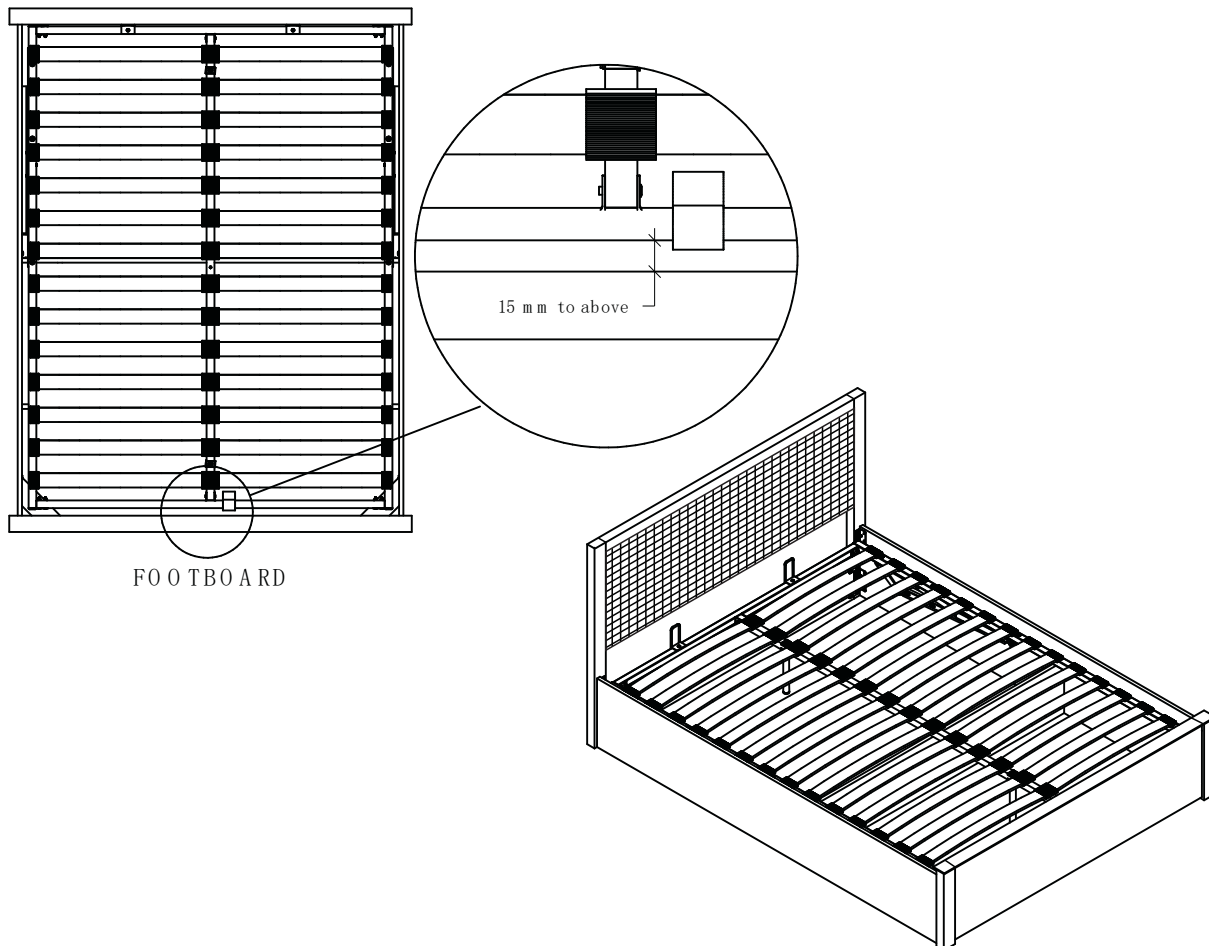

CAUTION :

PLEASE USE HYDRAULIC PUMP STOPPER FOR SAFETY PURPOSE.

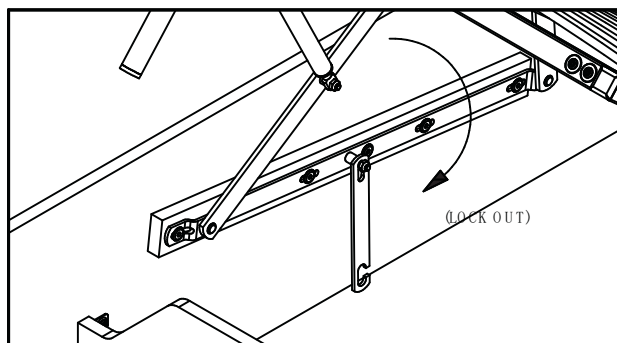
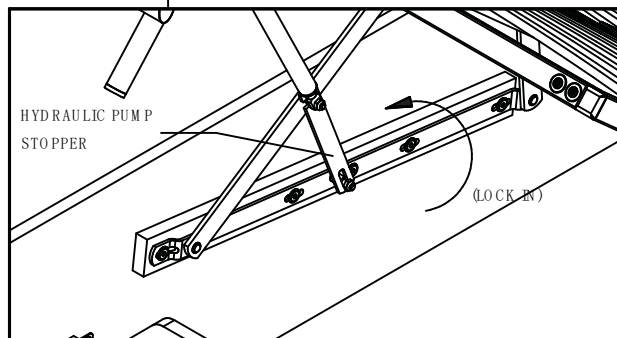
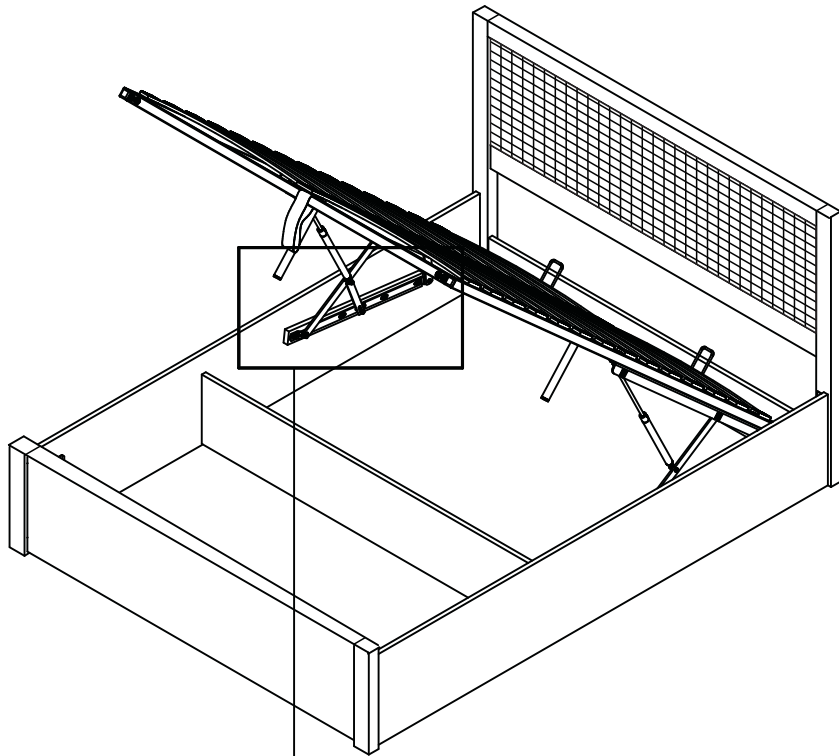

Important Ottoman Safety Warnings

- . Caution. This bed uses a pressurised mechanism.
- . Use caution when operating - Always use two hands at arm's length, and only where illustrated on the product.
- . You must ensure the mattress is on the bed frame before lifting the mechanism - Failure to do so may result in injury.
- . Please ensure Children and pets are kept away from the bed when operating the bed mechanism.
- . If removing the mattress, make sure that the frame is secured as it could flip open.
- . Only use the storage compartment when the frame is fully raised in the 'up' position.
- . No children or animals are left unattended when the frame is in the 'up' position.
- . Do not remain on the bed whilst the lifting mechanism is in use.
- . Beware of Entrapment - Keep both hands clear of mechanism when operating the mechanism.
- . When lifting the bed remove all bedding - Except the fitted sheet.

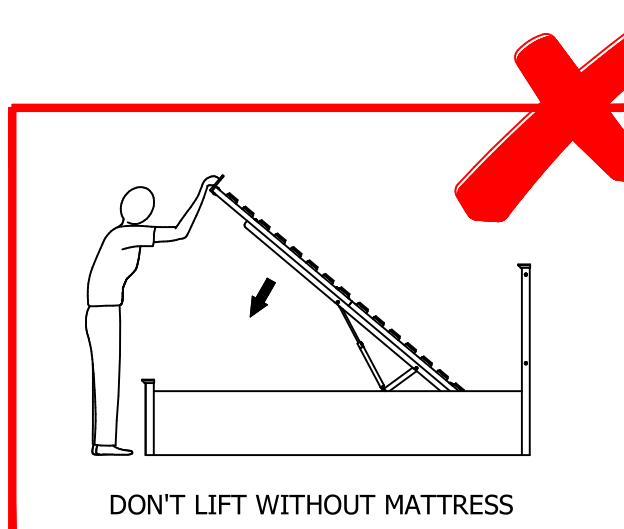
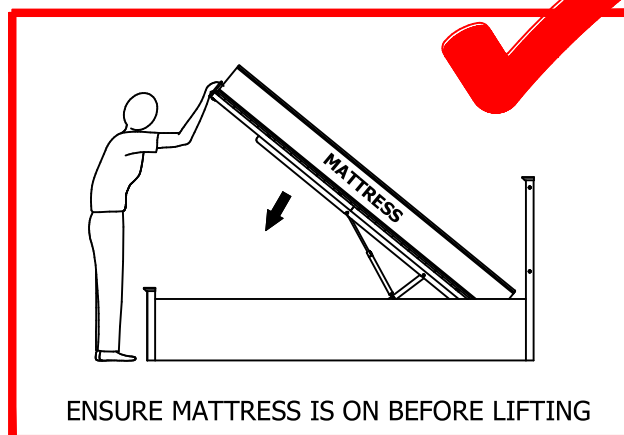

Please dispose of all packaging safely.

General Care & Maintenance

Wipe clean with a slightly damp cloth.
Avoid the use of all household cleaners and abrasives.

Periodically check all screw & fixings to ensure they are secure.

When moving your product, carefully lift into place. Never drag or push the product across the floor as this will cause damage to the joints. If the product is used on hard flooring, such as wood or laminated floor, you must place some protection under the legs to stop the product from moving. If this is not adhered to, it could result in failure to the product that will invalidate the warranty.

For more information on cleaning and product care visit:
<https://www.happybeds.co.uk/help-and-advice>

Notes

In the unlikely event that you have problems putting this product together or have damaged or missing parts, please contact us by visiting:
<https://www.happybeds.co.uk/customer-service>