

Assembly Instructions

Important before assembly:

Read these instructions carefully before assembling or using the product.

Please check the contents of the boxes before attempting to assemble this product. The instructions will have a checklist of parts and fittings.

Assemble the product as close to its intended final location/room as possible.

Health & Safety:

This product or some parts of this product will be heavy. Please use an assistant when lifting.

Please keep small parts out of reach of children.

Always use on a level, even surface.

DO NOT jump on the product or any of its parts.

DO NOT use this product if any parts are missing, damaged or worn.

DO NOT use this product unless all fixings are secured.

Further instructions are on the following pages.

Please keep these instructions for future reference.



This product or some parts of this product will be heavy. Please use an assistant when lifting.



Never drag or push the pieces across a hard or stone floor as this will cause damage to the joints. Use a carpet or a rug for extra care.



If you have problems assembling or have damaged or missing pieces, please contact our customer services (details at the back of these instructions)



Important for Ottoman and other gas lift beds

Note:

The bed base is in the upright position when first assembled as the gas lifts are fully extended during shipment for safety. After assembly a firm downward push will be required to overcome any resistance in the gas lifts as these may initially stick. We suggest placing a mattress on top of the bed base to aide this and also test the operation of your new lift up bed by lifting and pushing down the bed base a few times to allow the lifting mechanism to bed in.

The lift mechanism provides assistance with the lift of the mattress fitted to the base. It does not lift the mattress for you. The system has been designed to effectively lift the base system fitted with a variety of mattress weights and combinations of depths. Depending on the combination of the mattress weight and depth determines the degree of assistance provided by the mechanism.

Following the installation of the mechanism lift, pull the base up and down a few times to free off the system. The gas cylinders fitted to the system may be stiff when first used or if the system has not been operated for a period of time.

Use the strap handles to lift up the mattress base using two hands. Pull the mattress base down using two hands equally spaced from the centre of the mattress base. DO NOT pull down on one side of the base only as this is likely to damage the base system with potential failure of the mattress base system and lift mechanism.

Do NOT operate the lift up mechanism without the mattress placed on the base.

Caution:

Do NOT allow children to operate the lift mechanism.
Do NOT allow children near the lift base when operating the mechanism.
Do NOT allow children in the area of the internal storage base.
Keep hands clear of the mechanism when operating the base system.
Do NOT stand inside the bed or the internal storage base.
Do NOT overload the internal storage base.

NEW FRANCIS OTTOMAN BED 3'FT ASSEMBLY INSTRUCTIONS

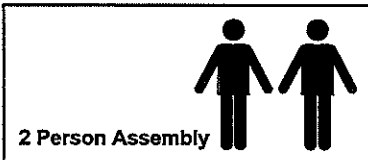
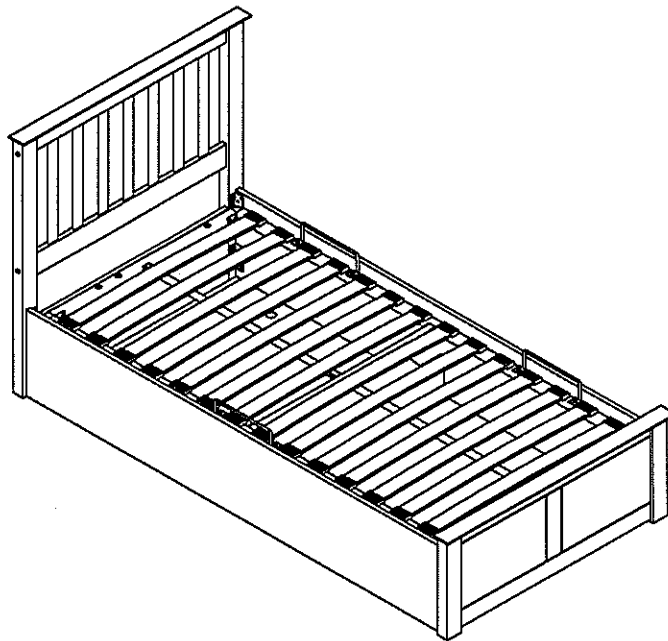

Important informations

Please take the time to carefully read through the whole of these instructions before you commence.

Keep these instructions for future reference.

Unpack, inspect and check aof all of the contents.

Please dispose of all packing safely.

Small components parts could choke a child if swallowed.

We strongly recommend that you keep children well away from the work area.

It would be sensible to lay a sheet or blanket on the floor where you intend to work to avoid scratching this product and protect your floor.

This product is heavy. Take extreme care when lifting to avoid personal injury or damage to the product.

This bed is heavy. Always lift the bed with to people.

Assemble the product as close to its intended final position in the room as possible.

Keep any sharp object away from the bed frame.

HANDY HINT: If you keep the hardware in a bowl during assembly you will be less likely to lose them.

HEALTH & SAFETY

DO NOT: jump on this bed frame.

DO NOT: use this bed frame if any parts are missing, damaged or worn.

DO NOT: use this bed frame unless all fixings are secured.

DO NOT: push the bed frame as this will damage the legs.

Always lift the bed frame with two people to reposition.

Always use on a level, even surface.

Following installation of the mechanism lift / pull the base up and down a few times to free of the system-the gas cylinders fitted to the system may be stiff when first time used or if the system has not been operated for a period of time. The mattress must be fitted to the base.

Use the strap handle to lift up the mattress base using tow hands-Pull the mattress base down using two hand equally spaced from the mattress.

WARNING: If this bed is placed on a non-carpeted floor you must place some protection under all legs to stop the bed frame from moving. If this is not adhered to there is no guarantee if the bed frame collapses.

WARNING: This storage bed frame has a powerful, mechanism and after assembly should only be opend when mattress is in place.

CAUTION

DO NOT: allow children to operate the mechanism.















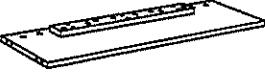
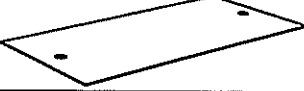

DO NOT: allow children near the lift base when operating the mechanism.

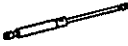

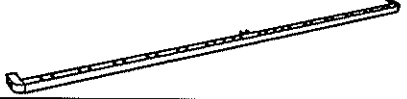

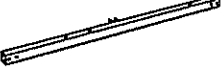















DO NOT: allow children in the area of the internal storage base.

Keep hands clear of the mechanism when operating the system.

DO NOT: stand inside the bed / on the internal storage base.

DO NOT: overload the internal storage.

PART LIST				
PART	DESCRIPTION		QTY	BOX
1	Headboard Frame		1	1/3
2	Left Wooden Post		1	
3	Right Wooden Post		1	
4	Footboard		1	2/3
5	Side Rail - Left & Right		2	3/3
6	Back Storage Panel		1	2/3
7	Base Panel		4	1/3
8	Center Storage Panel		1	2/3
9	Left Hydraulic Base Support		1	
10	Right Hydraulic Base Support		1	
11	Hydraulic Pump		2	
12	Back Side Bar		1	3/3
13	Front Side Bar		1	
14	End Bar Left		1	
15	End Bar Right		1	
16	Center Bar		1	
17	Middle Bar		2	
18	Wood Slat		14	

HARDWARE LIST (Found in box 3)				
PART	DESCRIPTION		QTY	BOX
A	Mini Fix		8	3/3
B	M8 x 30mm Wood Dowel		12	
C	ML-CB (Metal Corner Support)		2	
D	M6 x 90mm JCBC Bolt RBW + Barrel Nut		4	
E	M8 x 25mm JCBC Bolt RBW		16	
F	M8 x 15mm JCBC Bolt RBW		8	
G	M6 x 30mm JCBC Bolt BLK		4	
H	M6 x 45mm JCBC Bolt BLK		8	
I	Flat Bracket		4	
J	Base Handle		3	
K	M8 x 20mm JBCB Bolt RBW		8	
L	M6 x 40mm JCBC Bolt BLK		8	
M	M8 x 45mm JCBB Bolt RBW c/w Nut Bracket, Spring Washer & Flat Washer		6	
N	Single End Plastic Cap		28	
O	Self adhesive 4mm x 35mm		2	
P	Wood Button		4	
Q	M6 Allen Key		1	
R	M8 Allen Key		1	
S	M12.8 Spanner		1	
T	Washer Bracket		4	

** You will also need a screw driver and small mallet (not provided).

Step 1: Attach the headboard frame (1) and back storage panel (6) to the left wooden post (2) and right wooden post (3). Secure the headboard frame using hardware parts B, D and P, then secure the back storage panel with hardware parts A and B.
DO NOT use any power tools as this may damage the frame and will invalidate any claim.

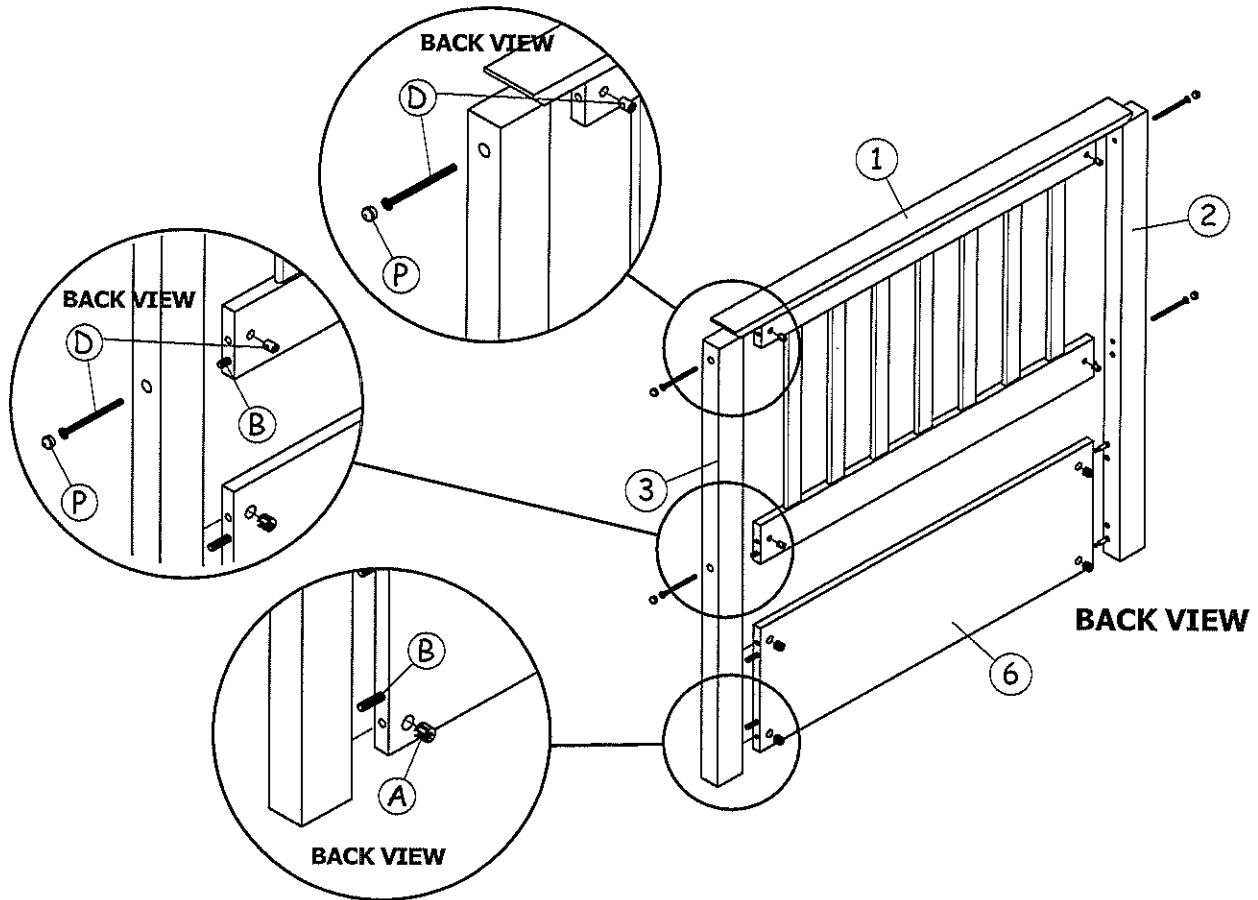

Step 2: Join together the left side rail and right side rail (5) with the centre storage panels (8) using hardware parts A and B.
DO NOT use any power tools as this may damage the frame and will invalidate any claim.

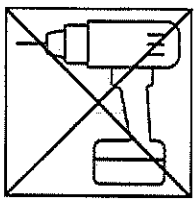
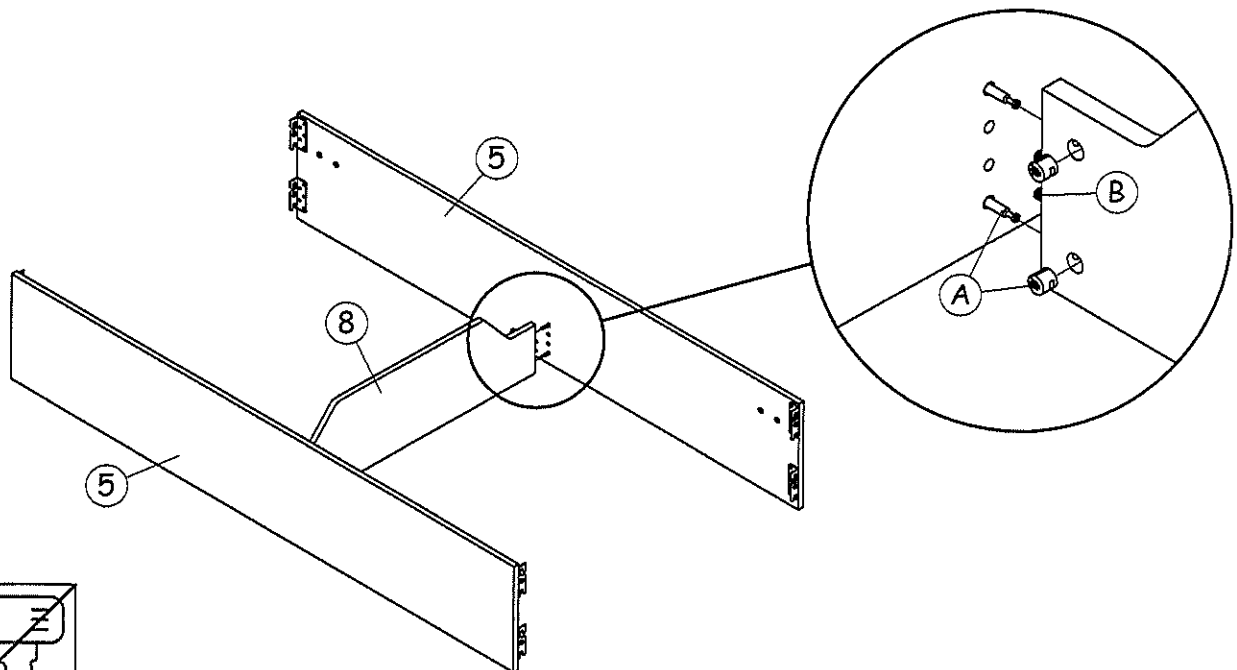

Step 3: Attach the headboard frame (1) and footboard (4) to the side rails using hardware part E.
DO NOT use any power tools as this may damage the frame and will invalidate any claim.

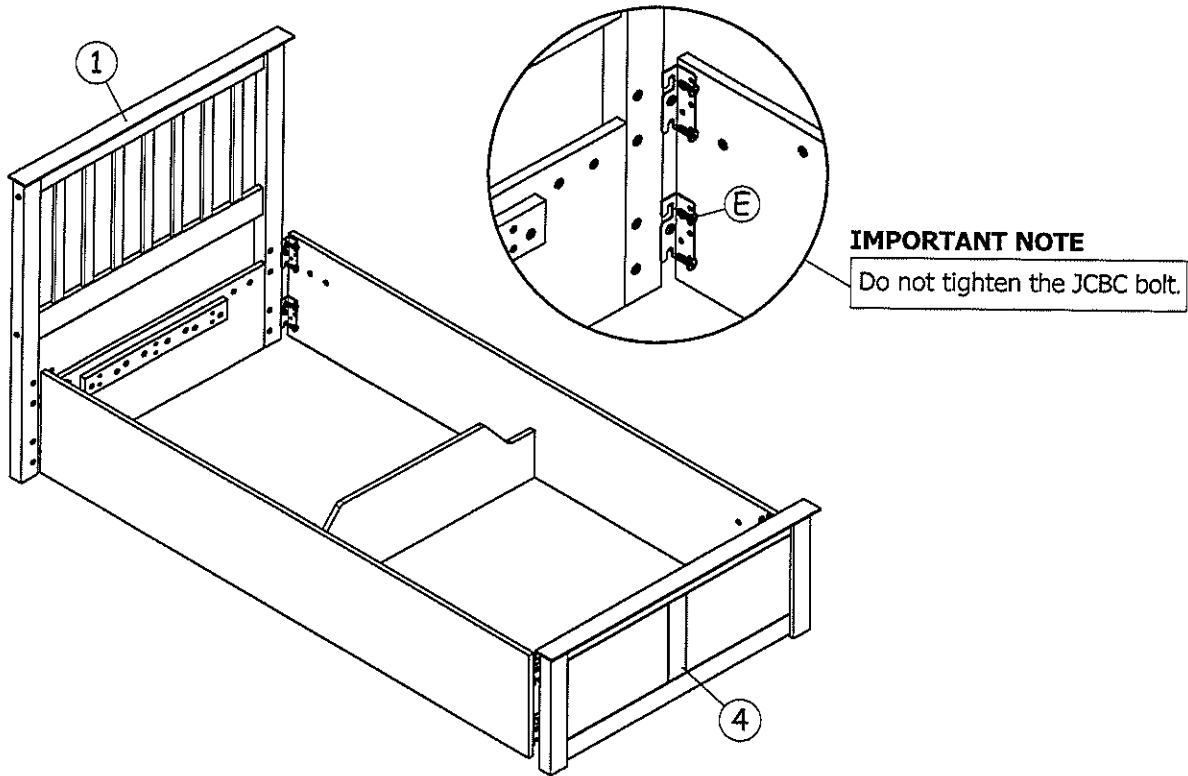

Step 4: Insert the base panel (7) to the position.

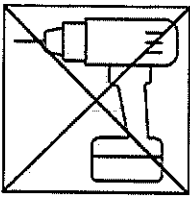
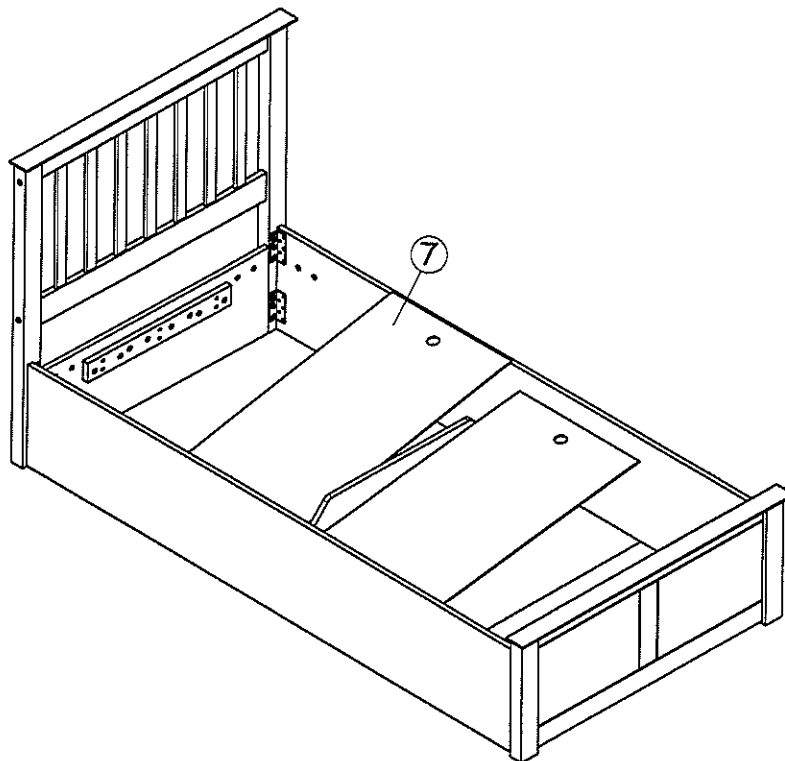

Do Not Use Power Tools

Step 5: Firstly, fix the hydraulic pump to each hydraulic base support as shown in diagram 5.1

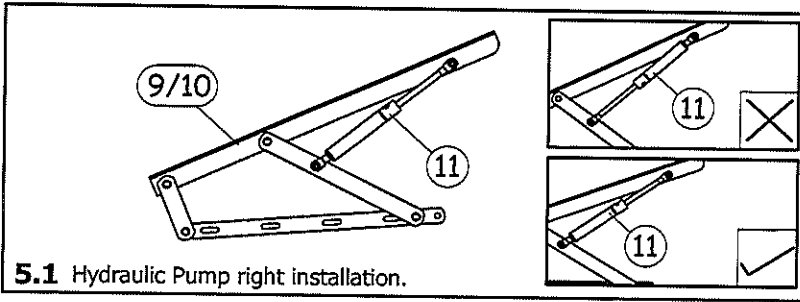

5.1 Hydraulic Pump right installation.

Next ensure your hydraulic opening side, locate your hydraulic base support through the JCBC holes L1, L2, L3 & L4 or R1, R2, R3 & R4 at the headboard and footboard as shown in diagram 5.2.

OPTION 1 (LEFT OPENING)

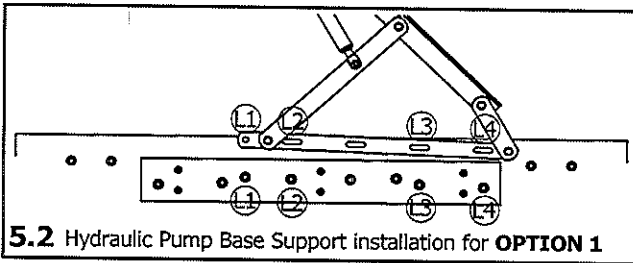

5.2 Hydraulic Pump Base Support installation for **OPTION 1**

OPTION 2 (RIGHT OPENING)

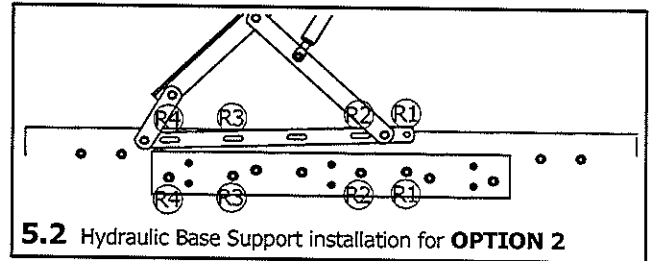

5.2 Hydraulic Base Support installation for **OPTION 2**

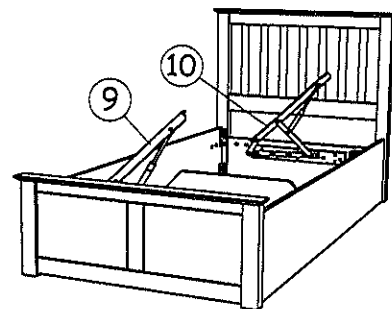
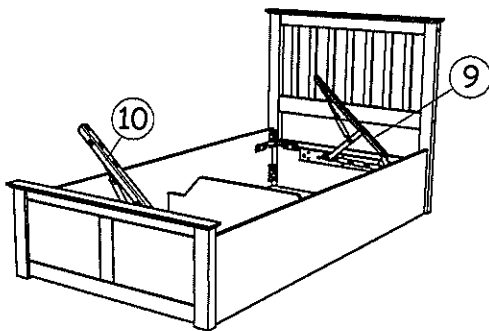

Make sure to fix bolts K at round end hole first (L1/R1) as shown in diagram 5.3 and do not tighten yet. Finally, fix all bolts and tighten all bolts as shown in diagram 5.4.

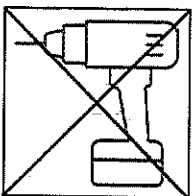
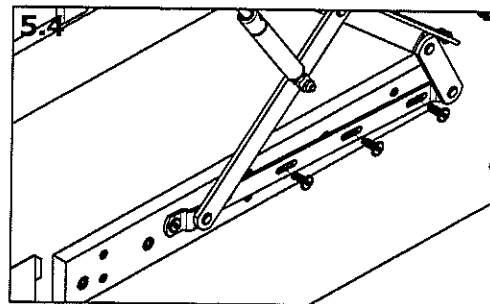
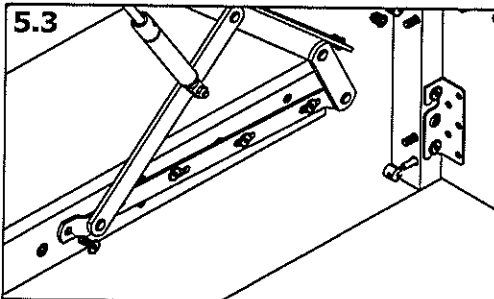

Do Not Use Power Tools

Step 6: Attach hardware part C using hardware parts F.
DO NOT use any power tools as this may damage the frame and will invalidate any claim.

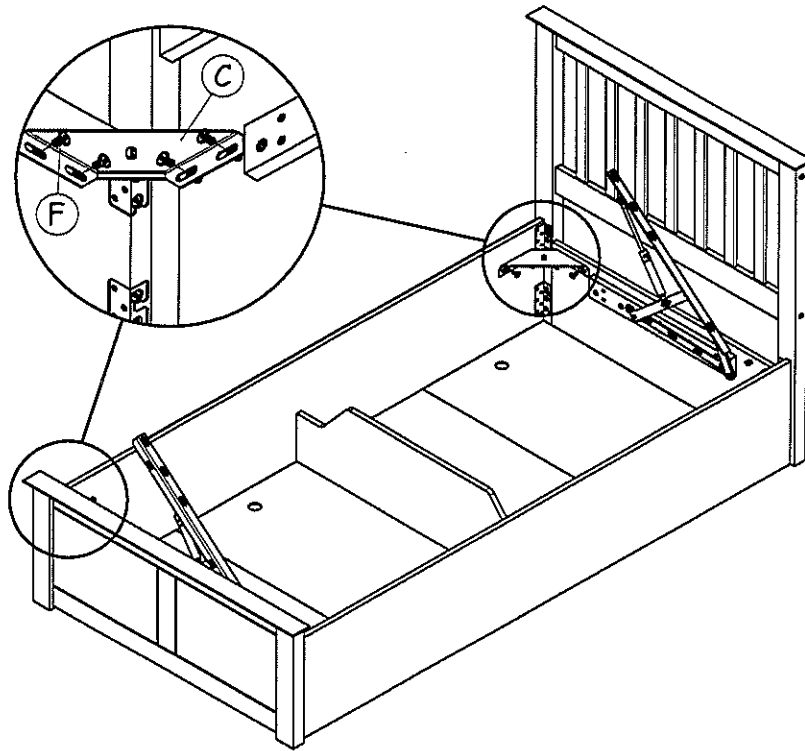

Step 7: Join together the front, back bed base (12)(13) and end bar left, right (14)(15) using hardware parts H, I and T. Attach parts (16) and (17) using hardware part G & L.
DO NOT use any power tools as this may damage the frame and will invalidate any claim.

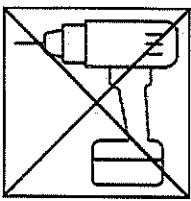
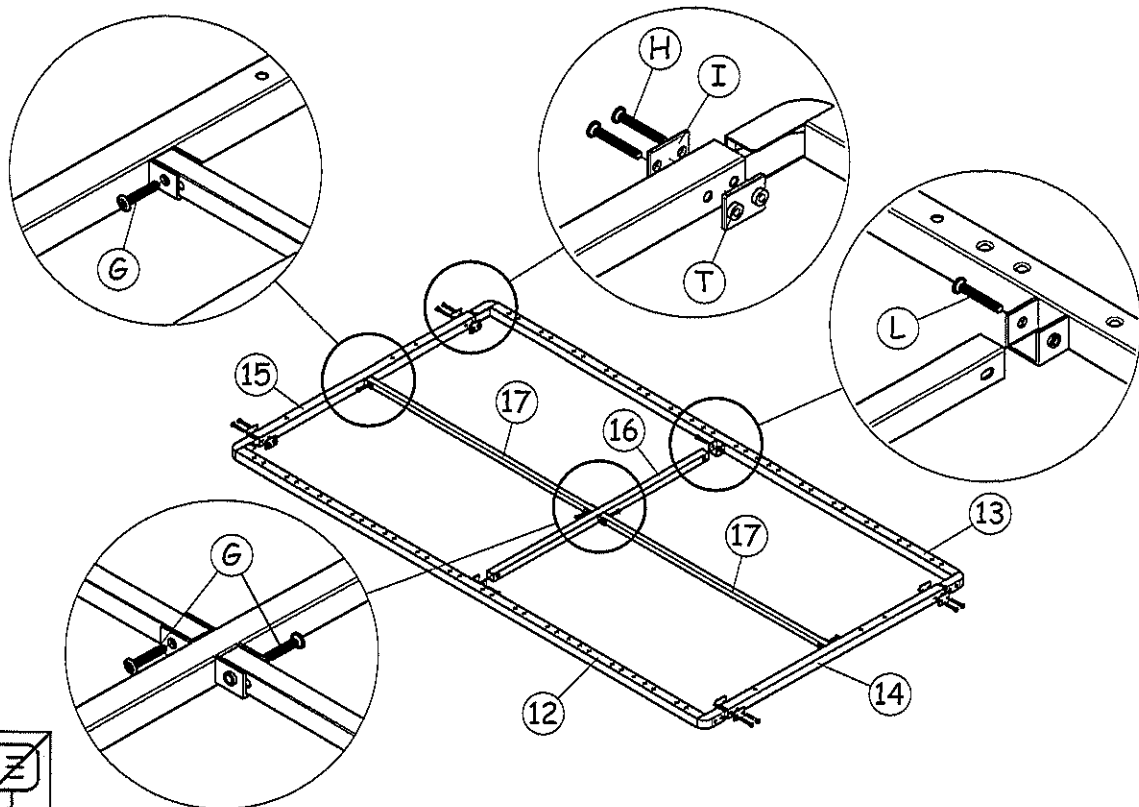

Do Not Use Power Tools

Step 8: Fit the slat cap N onto the spring slat (18) and insert into the pre-drilled holes. Please note you may need to press firmly into place. After that fix base handle J to the bed base with bolts L as shown.

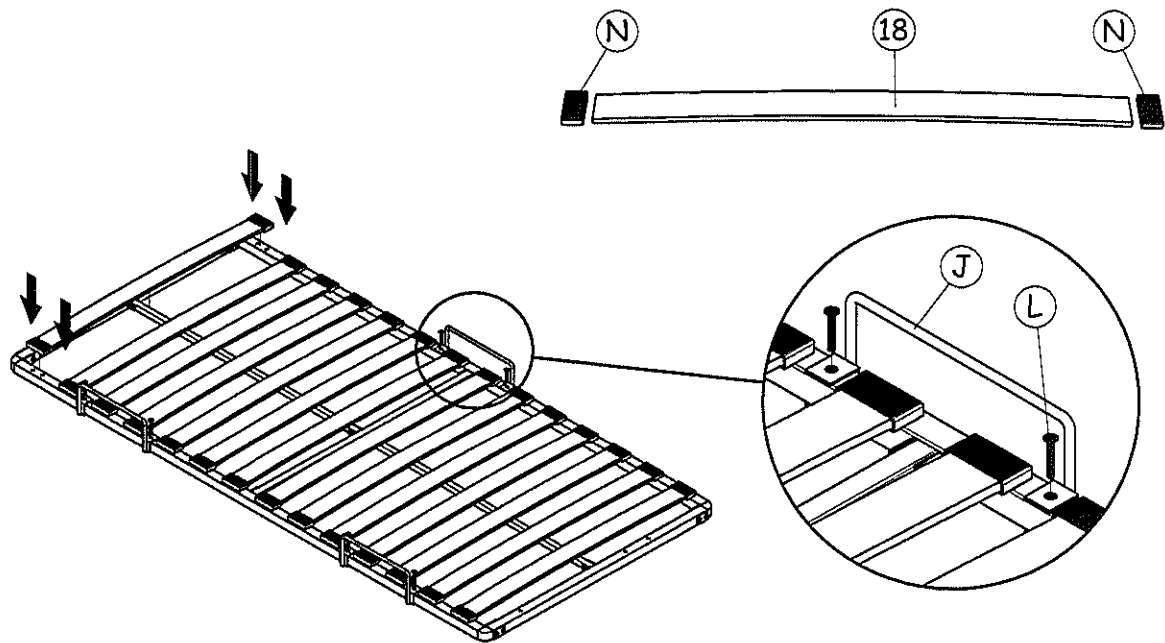

Step 9: Assemble the bed base on the left & right hydraulic frame and fix bolts starting from '1' to '3' as shown and then stick it the self adhesive O as shown. DO NOT use any power tools as this may damage the frame and will invalidate any claim.

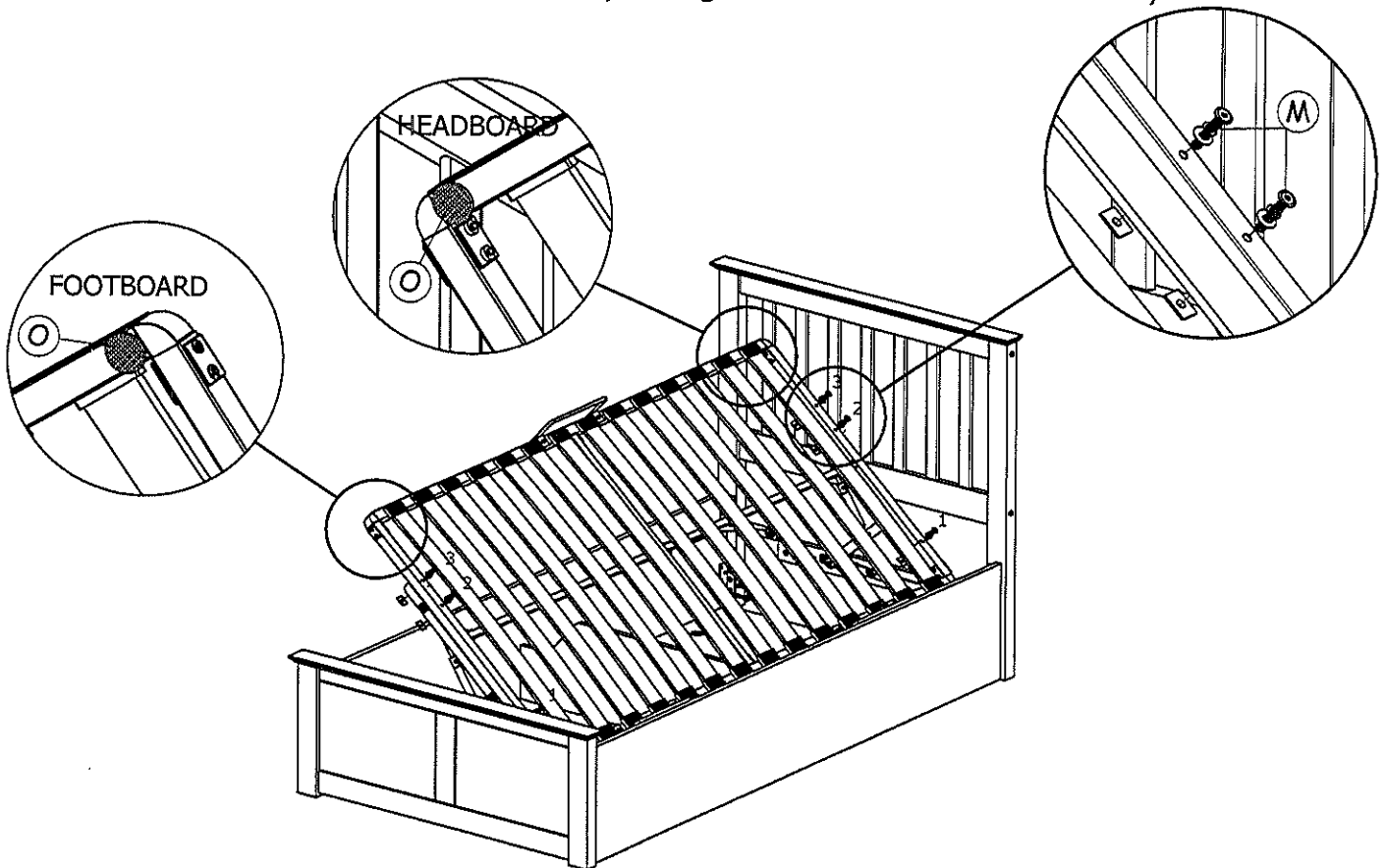

Step 10: Adjust the bed base, make sure that the distance with the side rail approximately 15mm to above. Tighten all bolts and screws.

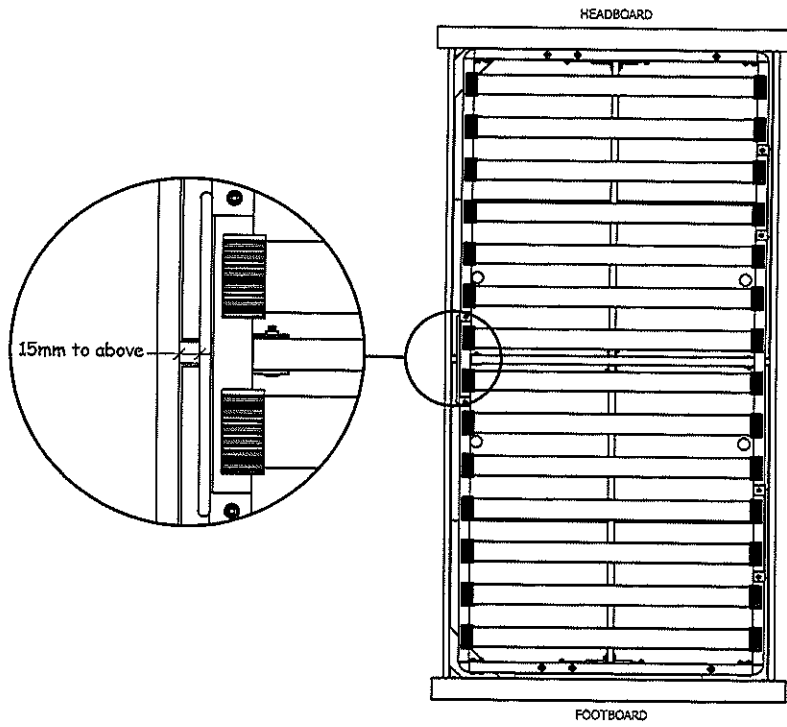

THE BED HAS BEEN FULLY ASSEMBLED

Option 1 (LEFT OPENING)

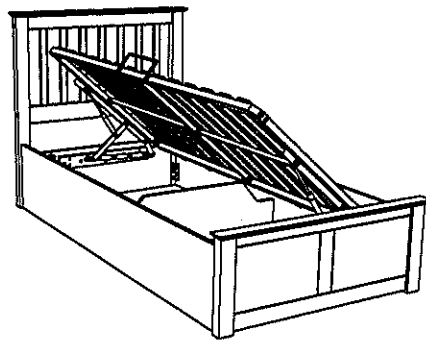
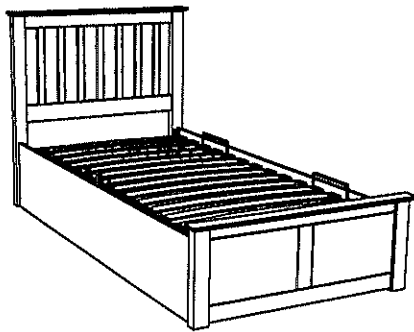

Option 2 (RIGHT OPENING)

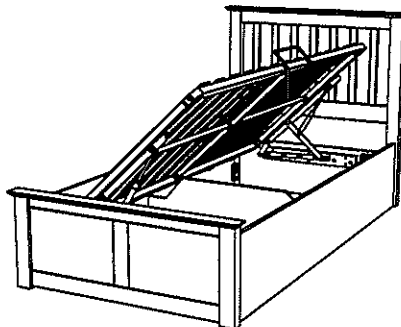
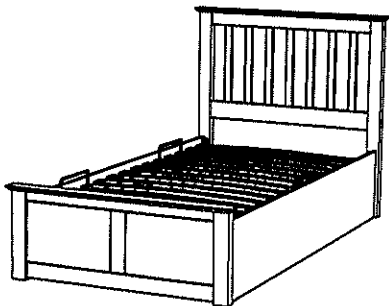

IMPORTANT NOTE

WHEN THE BED IS BUILT AND THE MATTRESS FRAME IS AT 45 DEGREE ANGLE PLEASE PLACE THE MATTRESS ON THE BED.

PLEASE NOTE THAT THE WEIGHT OF THE MATTRESS IS REQUIRED TO HELP CLOSE THE BED.

TO LOWER THE SLEEPING PLATFORM STAND AT THE FOOT END OF THE BED AND PUSH SHARPLY DOWNWARDS USING BOTH HANDS.

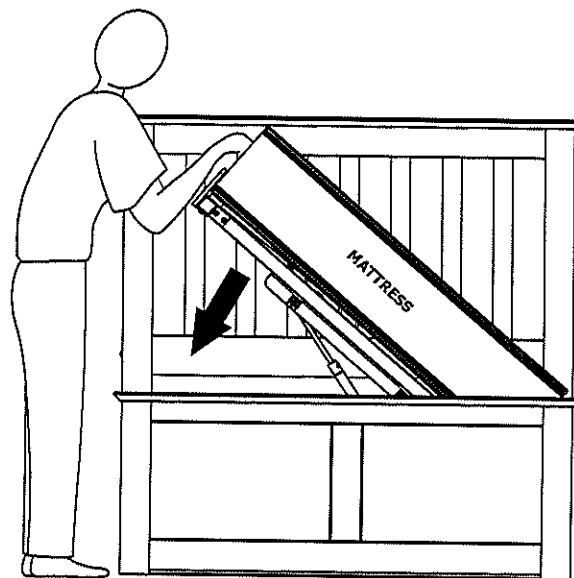

WARNING: Take care when assembling the base. Assemble the ottoman as closed to its final position. The Ottoman has a powerful, mechanism and after assembly should only be opened when the mattress is in place.

Important for Ottoman and other gas lift beds

Please follow these final steps to ensure the best experience with your new bed

- Please ensure the pistons are fitted to the bed frame.
- Please place the mattress on top of the bed frame.
- Standing at the foot of the frame (looking at the headboard) open the base and the press quite forcefully down on the mattress - please do not attempt to do this without the mattress being in place.
- Please do not pull on the strap handles.
- Please note as the pistons are full of gas - you will need to press heavily to release the compressed gas.
- Once done the pistons should start operating as normal.



General Care

Wipe clean with a slightly damp soft cloth.

Avoid the use of all household cleaners and abrasives.

When moving your furniture, carefully lift into place. never drag or push the pieces across the floor as this will cause damage to the joints and could result in failure to the product that will invalidate the warranty.

Recommendations

Periodical re-tightening of fixings.

Warning

This bed frame is heavy. Please use an assistant when lifting.

Notes

We've tried to make this bed frame as easy to assemble as possible. In the unlikely event that you have problems putting it together or damaged or missing pieces, please contact your retailer directly you purchased it from who will be able to resolve any issues.

Please dispose of all packaging safely.

General Care & Maintenance

Wipe clean with a slightly damp cloth.
Avoid the use of all household cleaners and abrasives.

Periodically check all screw & fixings to ensure they are secure.

When moving your product, carefully lift into place. Never drag or push the product across the floor as this will cause damage to the joints. If the product is used on hard flooring, such as wood or laminated floor, you must place some protection under the legs to stop the product from moving. If this is not adhered to, it could result in failure to the product that will invalidate the warranty.

For more information on cleaning and product care visit:
<https://www.happybeds.co.uk/help-and-advice>

Notes

In the unlikely event that you have problems putting this product together or have damaged or missing parts, please contact us by visiting:
<https://www.happybeds.co.uk/customer-service>