

## Assembly Instructions

### Important before assembly:

Read these instructions carefully before assembling or using the product.

Please check the contents of the boxes before attempting to assemble this product. The instructions will have a checklist of parts and fittings.

Assemble the product as close to its intended final location/room as possible.

### Health & Safety:

This product or some parts of this product will be heavy. Please use an assistant when lifting.

Please keep small parts out of reach of children.

Always use on a level, even surface.

DO NOT jump on the product or any of its parts.

DO NOT use this product if any parts are missing, damaged or worn.

DO NOT use this product unless all fixings are secured.

**Further instructions are on the following pages.**

Please keep these instructions for future reference.



This product or some parts of this product will be heavy. Please use an assistant when lifting.















Never drag or push the pieces across a hard or stone floor as this will cause damage to the joints. Use a carpet or a rug for extra care.



If you have problems assembling or have damaged or missing pieces, please contact our customer services (details at the back of these instructions)

## PARTS LIST

## HARDWARE LIST (Found in box3)





No	Item	Box	Qty	No	Item	Qty
1	Wooden Block	3	1	A	M5 Allen Key 	1
2	Footboard	3	1	B	Bolts (M8x30mm) 	8
3	Headboard	1	1	C	Spring Washer (M8) 	8
4	Side Rails	2	2	D	Flat Washer (M8x22mm) 	8
5	Cross support bar	3	2	E	Nuts (8x13) 	12
6	Cross Bar	3	1	F	Spanner (8x13) 	1
7	Corner Bracket	3	4	G	Bolts (M6x15mm) 	10
8	Centre support bar	2	1	H	Bolts (M8x15mm) 	4
9	Slats	3	28	I	M4 Allen Key 	1
10	Support Leg	3	1	J	Bolts (M8x45mm) 	10
11	Metal Hook	3	2	K	Bolts (M8x70mm) 	4
12	Pull Strap	3	1	L	Single Plastic caps 	28
13	Woven Fabric	3	1	M	Double Plastic caps 	14
14	Front frame rail	3	1			
15	Back frame rail	3	1			
16	Left frame rail	2	1			
17	Right frame rail	2	1			

**Step 1:**

To fix the side rails(4) to the headboard(3) and footboard(2) you will need to use hardware parts B, C and D with the M5 allen key(A).

To fix the wooden block(1) to the footboard(2) you will need to use hardware parts J with the M5 allen key(A).

**DO NOT use any power tools as this may damage the bed frame and will invalidate any claims.**

A	 M5 Allen Key (1pc)
B	 Bolts (M8x30mm) (8 pcs)
C	 Spring Washer (M8) (8 pcs)
D	 Flat Washer (M8x22mm) (8 pcs)
J	 Bolts (M8x45mm) (2 pcs)

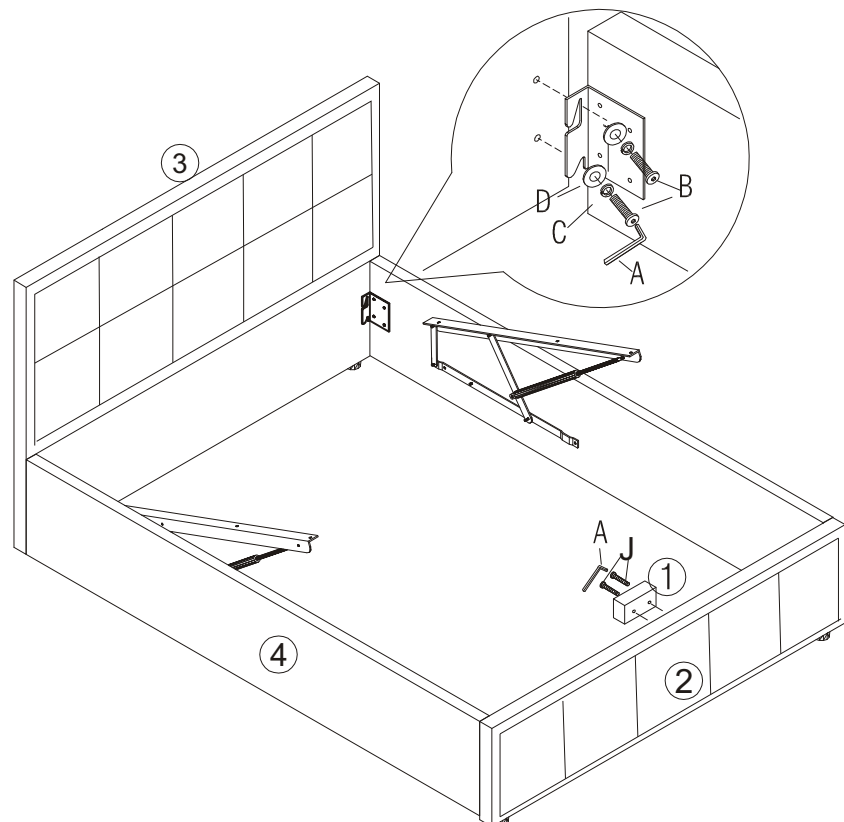



## Step 2:

To attach the corner bracket (7) to the headboard(3),footboard(2) and side rails(4)you will need to use hardware parts G and the M4 allen key(I).

To fix the cross bar(6) to the side rails ,you will need to use hardware parts G and the M4 allen key(I).

**DO NOT use any power tools as this may damage the bed frame and will invalidate any claims.**

G	 Bolts (M6x15mm) (10 pcs)
I	 M4 Allen Key (1 pc)

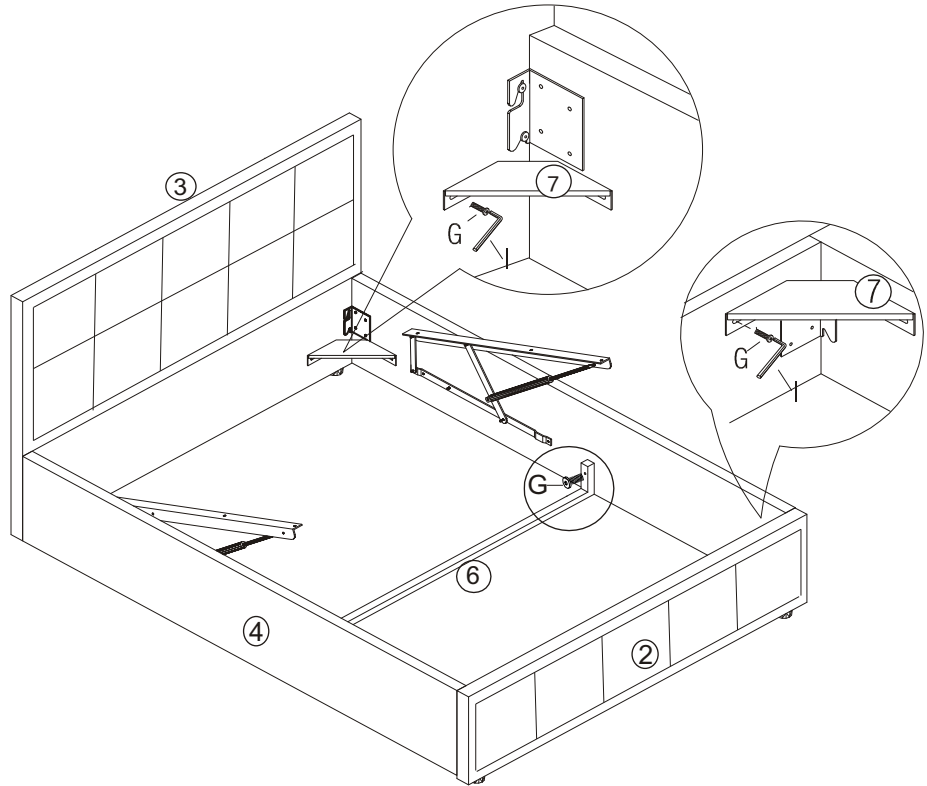

## Step 3:

To attach the front frame rail(14)and back frame rail ( 15 ) to the left frame rail (16)and right frame rail(17), you will need hardware parts H with the M5 allen key(A).





To attach the centre support bar ( 8 ) to the front frame rail(14)and back frame rail(15),you will need hardware parts J and E with the M5 allen key(A) and the spanner(F).

To attach the support leg ( 10 ) to the centre support bar(8),you will need hardware parts J and E with the M5 allen key(A) and the spanner(F).

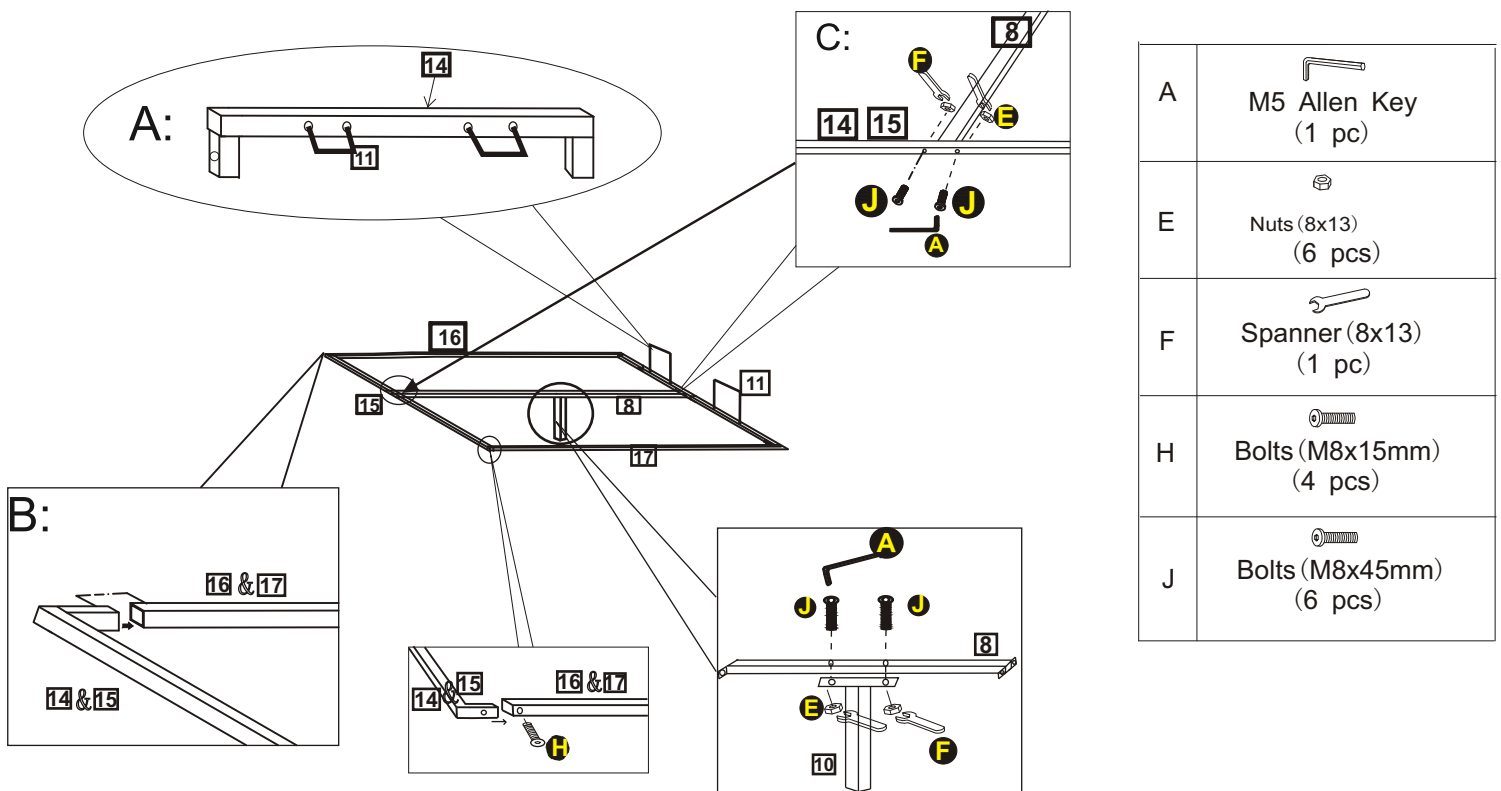
Insert the metal hook(11) to the front frame rail (14).

**DO NOT use any power tools. this may damage the bed frame and will invalidate any claims.**







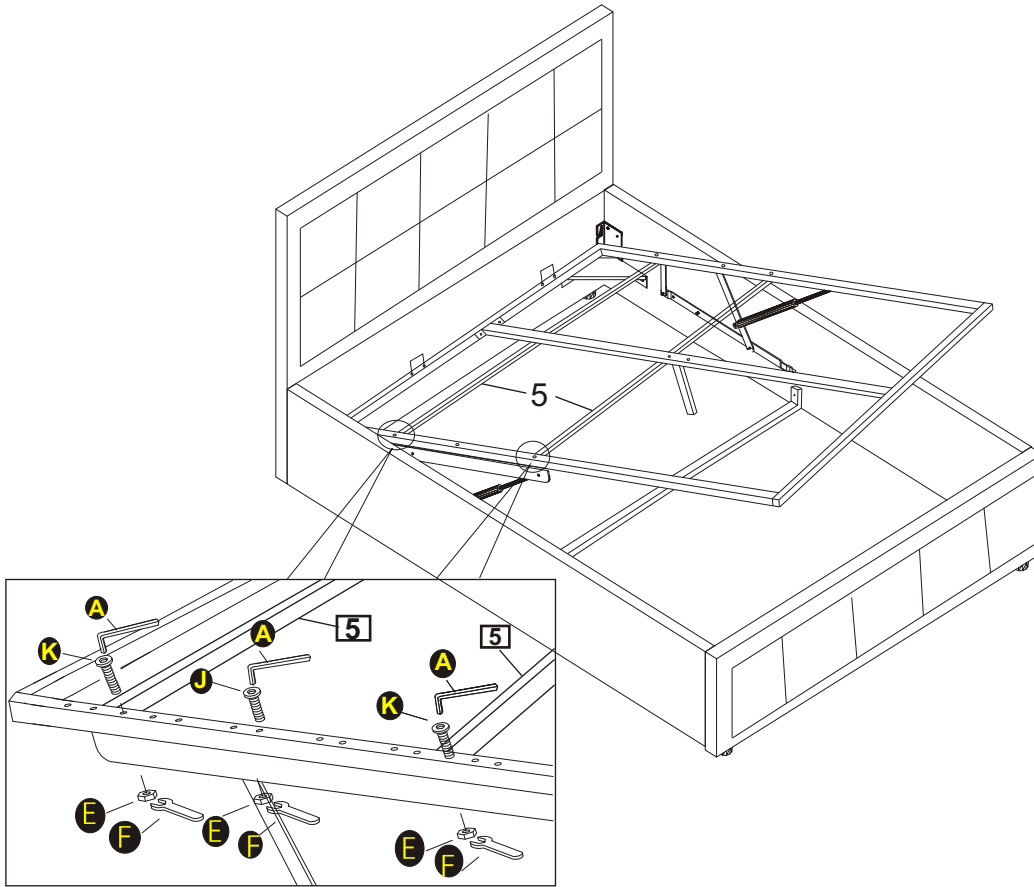

A	 M5 Allen Key (1 pc)
E	 Nuts (8x13) (6 pcs)
F	 Spanner (8x13) (1 pc)
H	 Bolts (M8x15mm) (4 pcs)
J	 Bolts (M8x45mm) (6 pcs)

### Step 4:

To attach the metal frame (14/15/16/17) and cross support bar (5) to the gas lift pre-fixed to the side rails, you will need to use hardware parts K, E and J with the M5 allen key (A) and the spanner (F).

**DO NOT use any power tools as this may damage the bed frame and will invalidate any claims.**



A	 M5 Allen Key (1 pc)
E	 Nuts (8x13) (6 pcs)
F	 Spanner (8x13) (1 pc)
K	 Bolts (M8x70mm) (4 pcs)
J	 Bolts (M8x45mm) (2 pcs)

### Step 5:

To attach the pull strap (12) to the back frame rail (15) you will place the pull strap (12) beneath the metal frame and then pull the strap on the inner side of the frame through the strap on the outer side of the frame to form a knot.

To assemble the slats (9) place a single plastic cap (L) onto each end of every slat then you need to push the double slat caps (M) into the metal frame.

Tilt the bedframe on to its side and attach the fabric base (13).

**DO NOT use any power tools as this may damage the bed frame and will invalidate any claims.**

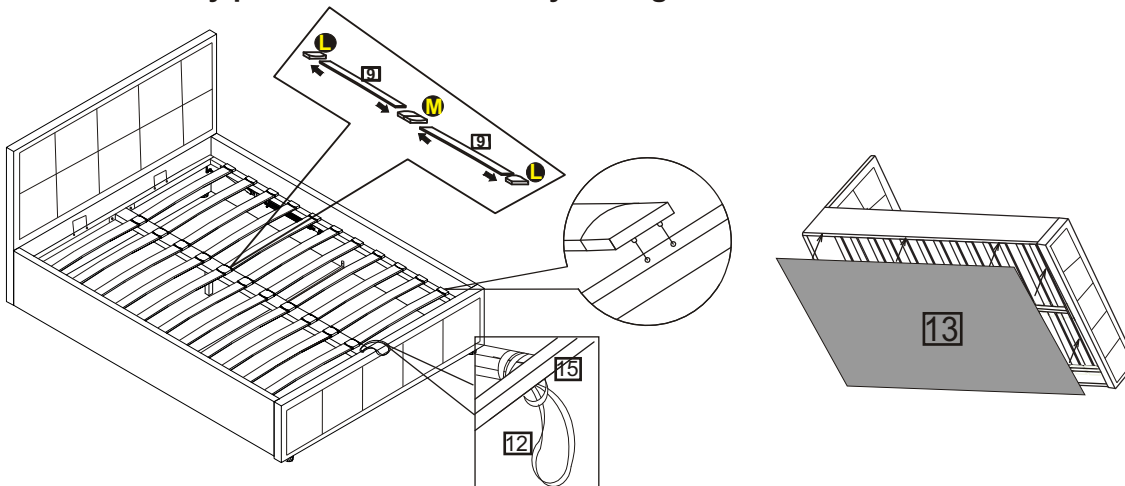

9	Slats (28 pcs)
L	Single Plastic caps (28 pcs)
M	Double Plastic caps (14 pcs)

## Important for Ottoman and other gas lift beds

**Please follow these final steps to ensure the best experience with your new bed**

- Please ensure the pistons are fitted to the bed frame.
- Please place the mattress on top of the bed frame.
- Standing at the foot of the frame (looking at the headboard) open the base and the press quite forcefully down on the mattress - please do not attempt to do this without the mattress being in place.
- Please do not pull on the strap handles.
- Please note as the pistons are full of gas - you will need to press heavily to release the compressed gas.
- Once done the pistons should start operating as normal.



Please dispose of all packaging safely.

## General Care & Maintenance

Wipe clean with a slightly damp cloth.  
Avoid the use of all household cleaners and abrasives.

Periodically check all screw & fixings to ensure they are secure.

When moving your product, carefully lift into place. Never drag or push the product across the floor as this will cause damage to the joints. If the product is used on hard flooring, such as wood or laminated floor, you must place some protection under the legs to stop the product from moving. If this is not adhered to, it could result in failure to the product that will invalidate the warranty.

For more information on cleaning and product care visit:  
<https://www.happybeds.co.uk/help-and-advice>

## Notes

In the unlikely event that you have problems putting this product together or have damaged or missing parts, please contact us by visiting:  
<https://www.happybeds.co.uk/customer-service>