

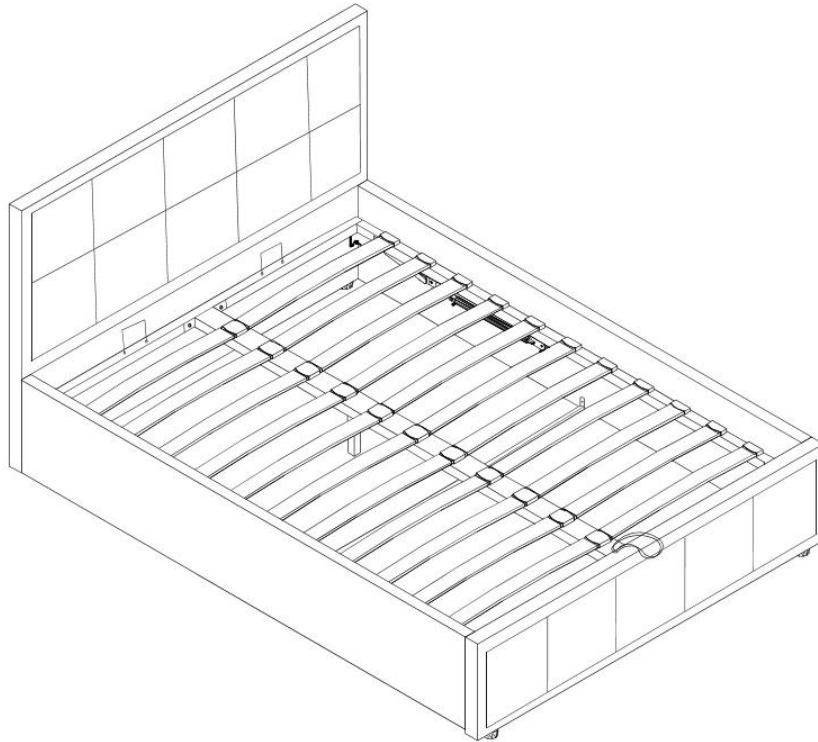

Assembly Instructions

Hannover Ottoman Bed 5FT



Important before assembly:

Read these instructions carefully before assembling or using the product.

Please check the contents of the boxes before attempting to assemble this product. The instructions will have a checklist of parts and fittings.

It would be sensible to lay a rug or a carpet on the floor where you intend to assemble the product, to void scratches and damaging the product or the floor.

Assemble the product as close to its intended final location/room as possible.

Do NOT use any power tools as this may damage the frame.

Health & Safety:

This product or some parts of this product will be heavy. Please use an assistant when lifting.

DO NOT jump on the product or any of its parts.

DO NOT use this product if any parts are missing, damaged or worn.

DO NOT use this product unless all fixings are secured.

Please keep small parts out of reach of children.

Always use on a level, even surface.

Please keep these instructions for future reference.

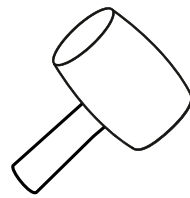

(Not metal)

These tools are not necessary, but may help to assemble certain parts of the product.

Do NOT use any power tools as this may damage the frame.



This product or some parts of this product will be heavy. Please use an assistant when lifting.

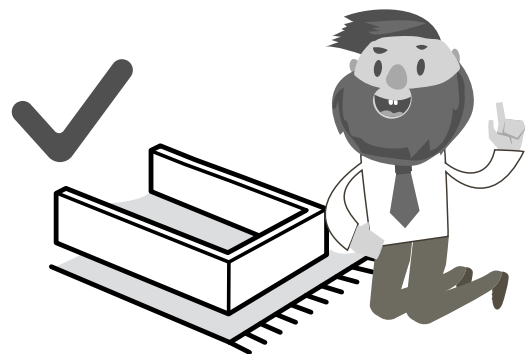

Never drag or push the pieces across a hard or stone floor as this will cause damage to the joints. Use a carpet or a rug for extra care.

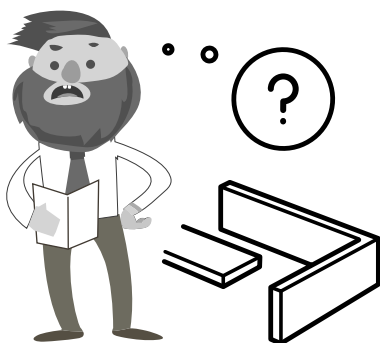

If you have problems assembling or have damaged or missing pieces, please contact us by visiting:

<https://www.happybeds.co.uk/customer-service>



Important for Ottoman and other gas lift beds

Note:

The bed base is in the upright position when first assembled as the gas lifts are fully extended during shipment for safety. After assembly a firm downward push will be required to overcome any resistance in the gas lifts as these may initially stick. We suggest placing a mattress on top of the bed base to aid this and also test the operation of your new lift up bed by lifting and pushing down the bed base a few times to allow the lifting mechanism to bed in.

The lift mechanism provides assistance with the lift of the mattress fitted to the base. It does not lift the mattress for you. The system has been designed to effectively lift the base system fitted with a variety of mattress weights and combinations of depths. Depending on the combination of the mattress weight and depth determines the degree of assistance provided by the mechanism.

Following the installation of the mechanism lift, pull the base up and down a few times to free off the system. The gas cylinders fitted to the system may be stiff when first used or if the system has not been operated for a period of time.

Use the strap handles to lift up the mattress base using two hands. Pull the mattress base down using two hands equally spaced from the centre of the mattress base. DO NOT pull down on one side of the base only as this is likely to damage the base system with potential failure of the mattress base system and lift mechanism.













Do NOT operate the lift up mechanism without the mattress placed on the base.

Caution:

Do NOT allow children to operate the lift mechanism.
Do NOT allow children near the lift base when operating the mechanism.
Do NOT allow children in the area of the internal storage base.
Keep hands clear of the mechanism when operating the base system.
Do NOT stand inside the bed or the internal storage base.
Do NOT overload the internal storage base.

PARTS LIST

HARDWARE LIST (Found in box3)





No	Item	Box	Qty	No	Item	Qty
1	Wooden Block	3	1	A	M5 Allen Key 	1
2	Footboard	3	1	B	Bolts (M8x30mm) 	8
3	Headboard	1	1	C	Spring Washer (M8) 	8
4	Side Rails	2	2	D	Flat Washer (M8x22mm) 	8
5	Cross support bar	3	2	E	Nuts (8x13) 	12
6	Cross Bar	3	1	F	Spanner (8x13) 	1
7	Corner Bracket	3	4	G	Bolts (M6x15mm) 	10
8	Centre support bar	2	1	H	Bolts (M8x15mm) 	4
9	Slats	3	28	I	M4 Allen Key 	1
10	Support Leg	3	1	J	Bolts (M8x45mm) 	10
11	Metal Hook	3	2	K	Bolts (M8x70mm) 	4
12	Pull Strap	3	1	L	Single Plastic caps 	28
13	Woven Fabric	3	1	M	Double Plastic caps 	14
14	Front frame rail	3	1			
15	Back frame rail	3	1			
16	Left frame rail	2	1			
17	Right frame rail	2	1			

Step 1:

To fix the side rails(4)to the headboard(3)and footboard(2) you will need to use hardware parts B,C and D with the M5 allen key(A).

To fix the wooden block(1) to the footboard(2)you will need to use hardware parts J with the M5 allen key(A).

DO NOT use any power tools as this may damage the bed frame and will invalidate any claims.

A	 M5 Allen Key (1pc)
B	 Bolts (M8x30mm) (8 pcs)
C	 Spring Washer (M8) (8 pcs)
D	 Flat Washer (M8x22mm) (8 pcs)
J	 Bolts (M8x45mm) (2 pcs)

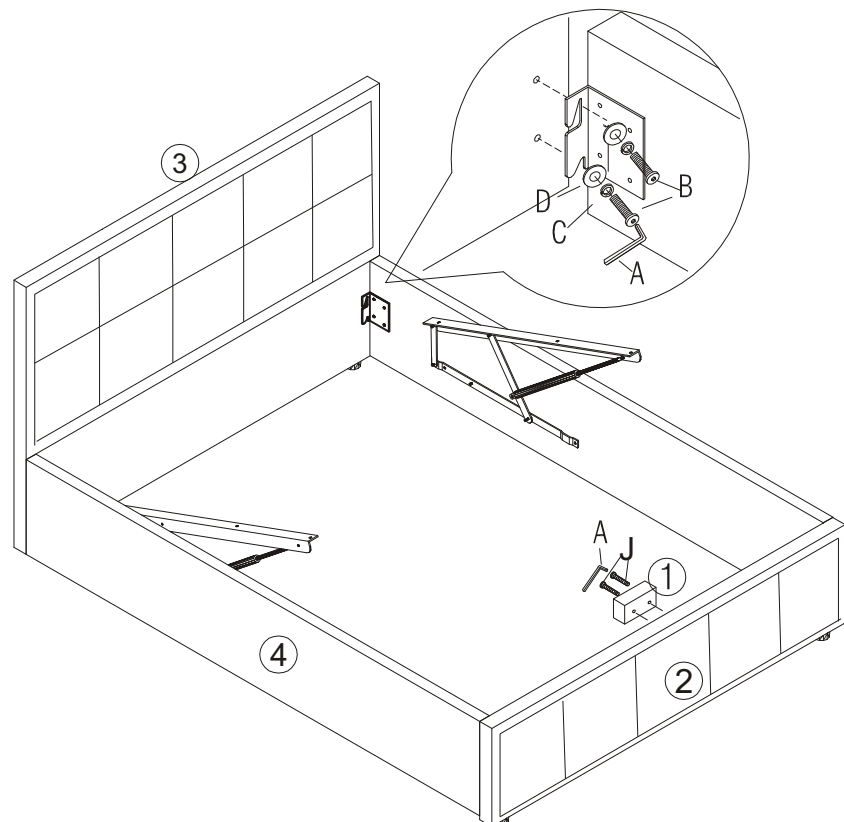



Step 2:

To attach the corner bracket (7) to the headboard (3), footboard (2) and side rails (4) you will need to use hardware parts G and the M4 allen key (I).

To fix the cross bar (6) to the side rails, you will need to use hardware parts G and the M4 allen key (I).

DO NOT use any power tools as this may damage the bed frame and will invalidate any claims.

G	 Bolts (M6x15mm) (10 pcs)
I	 M4 Allen Key (1 pc)

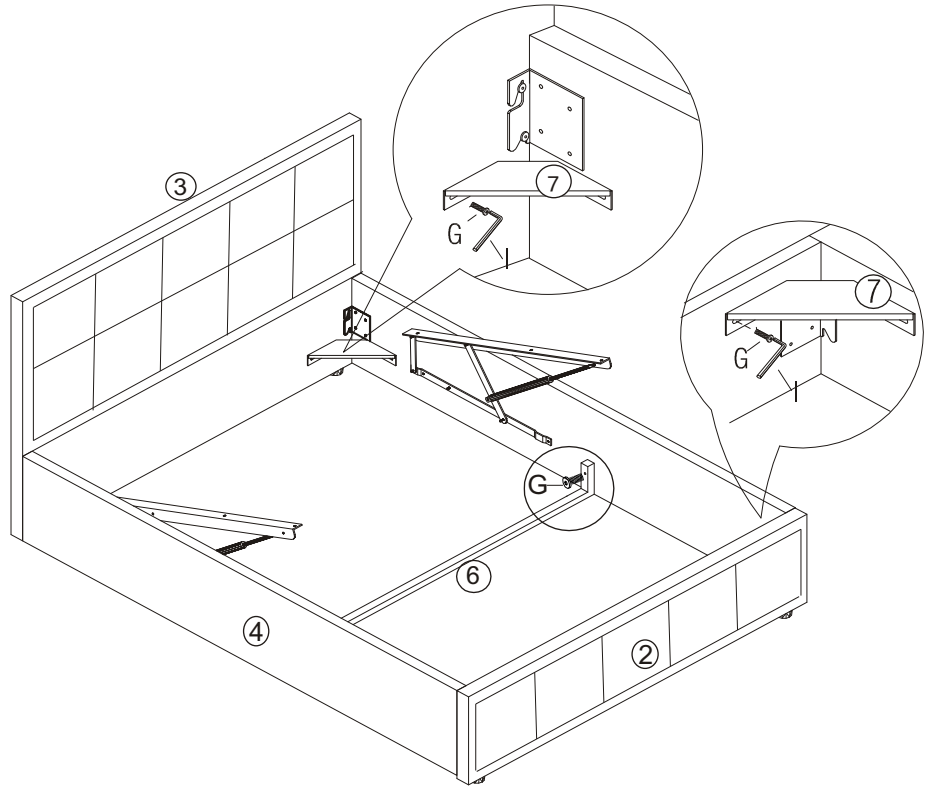

Step 3:

To attach the front frame rail (14) and back frame rail (15) to the left frame rail (16) and right frame rail (17), you will need hardware parts H with the M5 allen key (A).





To attach the centre support bar (8) to the front frame rail (14) and back frame rail (15), you will need hardware parts J and E with the M5 allen key (A) and the spanner (F).

To attach the support leg (10) to the centre support bar (8), you will need hardware parts J and E with the M5 allen key (A) and the spanner (F).

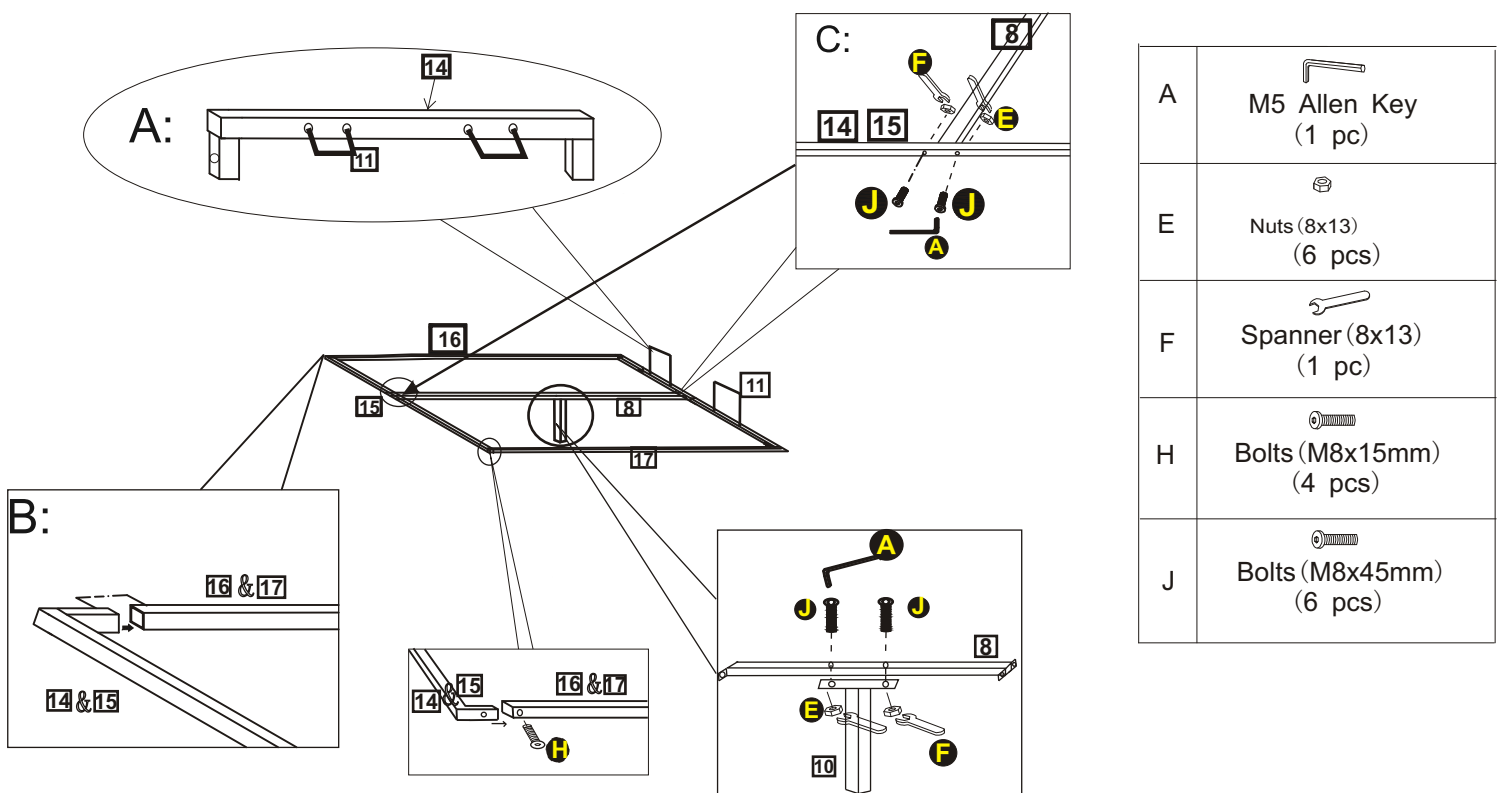
Insert the metal hook (11) to the front frame rail (14).

DO NOT use any power tools, this may damage the bed frame and will invalidate any claims.







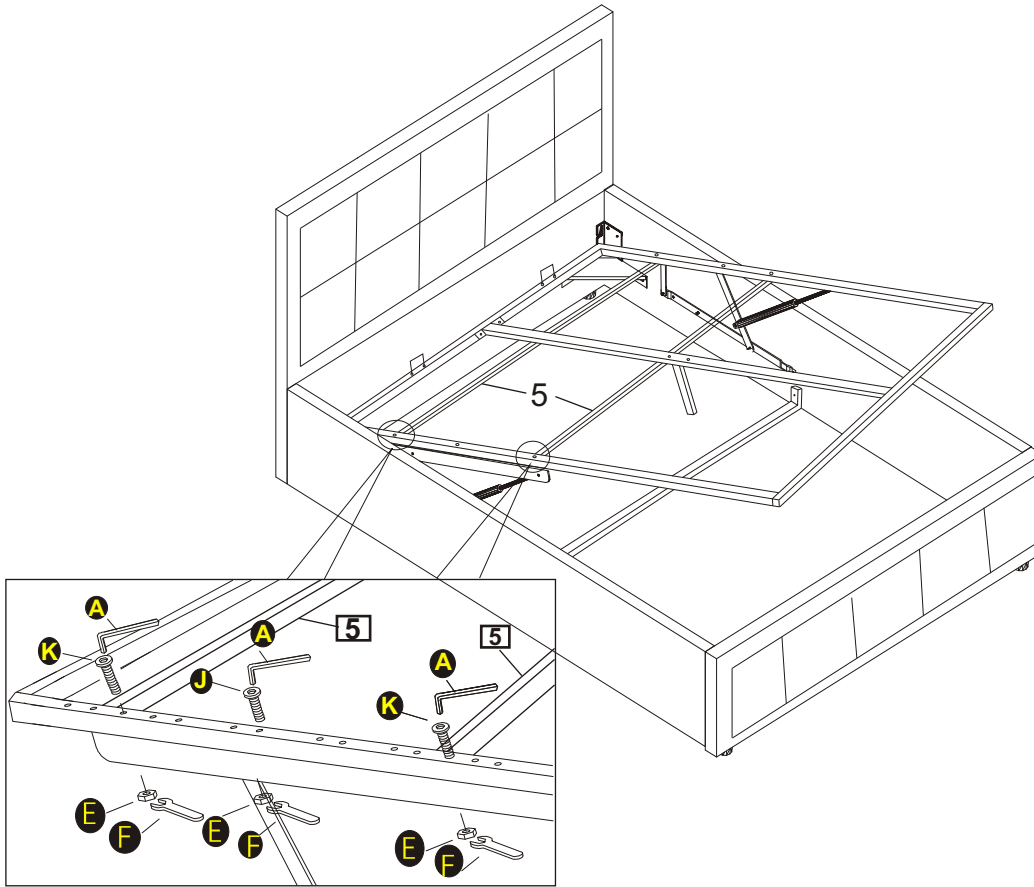

A	 M5 Allen Key (1 pc)
E	 Nuts (8x13) (6 pcs)
F	 Spanner (8x13) (1 pc)
H	 Bolts (M8x15mm) (4 pcs)
J	 Bolts (M8x45mm) (6 pcs)

Step 4:

To attach the metal frame (14/15/16/17) and cross support bar (5) to the gas lift pre-fixed to the side rails, you will need to use hardware parts K, E and J with the M5 allen key (A) and the spanner (F).

DO NOT use any power tools as this may damage the bed frame and will invalidate any claims.



A	 M5 Allen Key (1 pc)
E	 Nuts (8x13) (6 pcs)
F	 Spanner (8x13) (1 pc)
K	 Bolts (M8x70mm) (4 pcs)
J	 Bolts (M8x45mm) (2 pcs)

Step 5:

To attach the pull strap (12) to the back frame rail (15) you will place the pull strap (12) beneath the metal frame and then pull the strap on the inner side of the frame through the strap on the outer side of the frame to form a knot.

To assemble the slats (9) place a single plastic cap (L) onto each end of every slat then you need to push the double slat caps (M) into the metal frame.

Tilt the bedframe on to its side and attach the fabric base (13).

DO NOT use any power tools as this may damage the bed frame and will invalidate any claims.

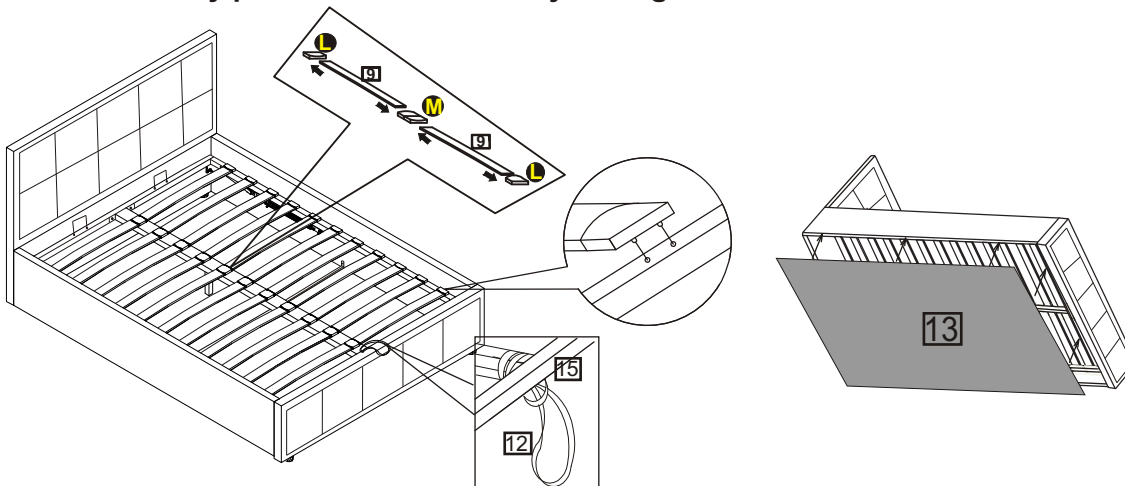

9	Slats (28 pcs)
L	Single Plastic caps (28 pcs)
M	Double Plastic caps (14 pcs)

Please dispose of all packaging safely.

General Care & Maintenance

Wipe clean with a slightly damp cloth.
Avoid the use of all household cleaners and abrasives.

Periodically check all screw & fixings to ensure they are secure.
When moving your product, carefully lift into place. Never drag or push the product across the floor as this will cause damage to the joints. If the product is used on hard flooring, such as wood or laminated floor, you must place some protection under the legs to stop the product from moving. If this is not adhered to, it could result in failure to the product that will invalidate the warranty.

For more information on cleaning and product care visit:
<https://www.happybeds.co.uk/help-and-advice>

Notes

We've tried to make this product as easy to assemble as possible. In the unlikely event that you have problems putting it together or have damaged or missing pieces, please contact us by visiting:

<https://www.happybeds.co.uk/customer-service>



www.happybeds.co.uk

