



Assembly Instructions

Important before assembly:

Read these instructions carefully before assembling or using the product.

Please check the contents of the boxes before attempting to assemble this product. The instructions will have a checklist of parts and fittings.

Assemble the product as close to its intended final location/room as possible.

Health & Safety:

This product or some parts of this product will be heavy. Please use an assistant when lifting.

Please keep small parts out of reach of children.

Always use on a level, even surface.

DO NOT jump on the product or any of its parts.

DO NOT use this product if any parts are missing, damaged or worn.

DO NOT use this product unless all fixings are secured.

Further instructions are on the following pages.

Please keep these instructions for future reference.



This product or some parts of this product will be heavy. Please use an assistant when lifting.



Never drag or push the pieces across a hard or stone floor as this will cause damage to the joints. Use a carpet or a rug for extra care.



If you have problems assembling or have damaged or missing pieces, please contact our customer services (details at the back of these instructions)

Assembly Instructions

4FT Lauren Twin & Double Bed

Part in Box 1

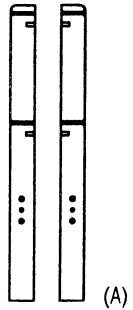

Head Post x 2

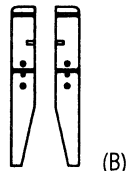

Foot Post x 2

Part in Box 2

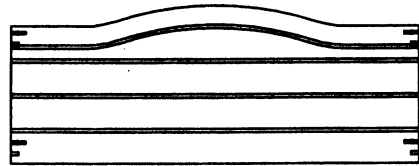

(C) Hb. Panel x 1

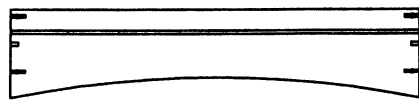

(D) Fb. Panel x 1

Part in Box 3

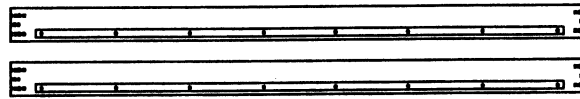

(E) Side Rail x 2

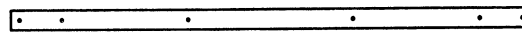

(F) Center Support x 1

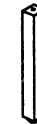

(G)

Support Legs x 4

Part in Box 4

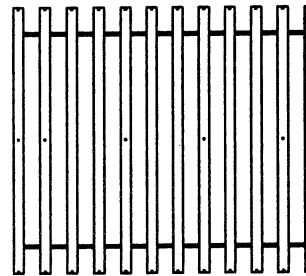

(H) Set of Slats x 1

Hardware List

1.	JCBC M6 x 70mm		x 8
2.	JCBC M6 x 100mm		x 8
3.	JCBC M6 x 65mm		x 4
4.	JCBC M6 x 45mm		x 2
5.	M4 Allen Key		x 1
6.	M6 x 15mm Barrel Nut		x 8
7.	Wood Dowel M10 x 40mm		x 10
8.	CSK M4 x 25mm		x 24
9.	M6 Hex . Nut		x 2
10.	Flat Washer		x 2
11.	Adjustable Screw		x 4
12.	M6 x 13mm (Short) Barrel Nut		x 8

Tool required for assembly.:

- * Allen Key (supplied)
- * Phillips Screwdriver
(not supplied)

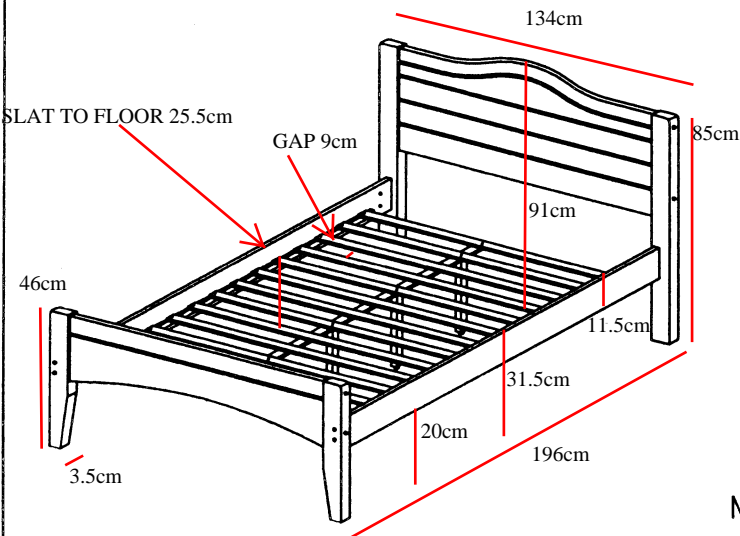

ASSEMBLY TIPS

Remove hardware from box and sort by size to check that all hardware and parts are present before assembling. Follow instructions below in the proper sequence to ensure fast, easy and correct assembly.

WARNING !!

DO NOT FULLY TIGHTEN ALL BOLTS UNTIL ALL PARTS ARE IN PLACE. FAILURE TO FOLLOW THIS INSTRUCTION MAY CAUSE THE BOLTS TO BE MISALIGNED DURING THE ASSEMBLY.



NOTE : DURING ASSEMBLY , DO NOT TIGHTEN ANY SCREWS UNTIL THE COMPLETE UNIT HAS BEEN ASSEMBLED.

Thank you for purchasing this quality product. Be sure to check all packed material carefully for small parts which may have come loose inside the carton during shipment. Place all parts on a clean , smooth surface such as a rug or carpet to avoid scratching the parts. Be sure you have all the parts and hardware before you begin assembly.

Assembly Instructions



Lauren Twin & Double Bed

1 Assemble the Head Post (A) to the Hb. Panel (C).

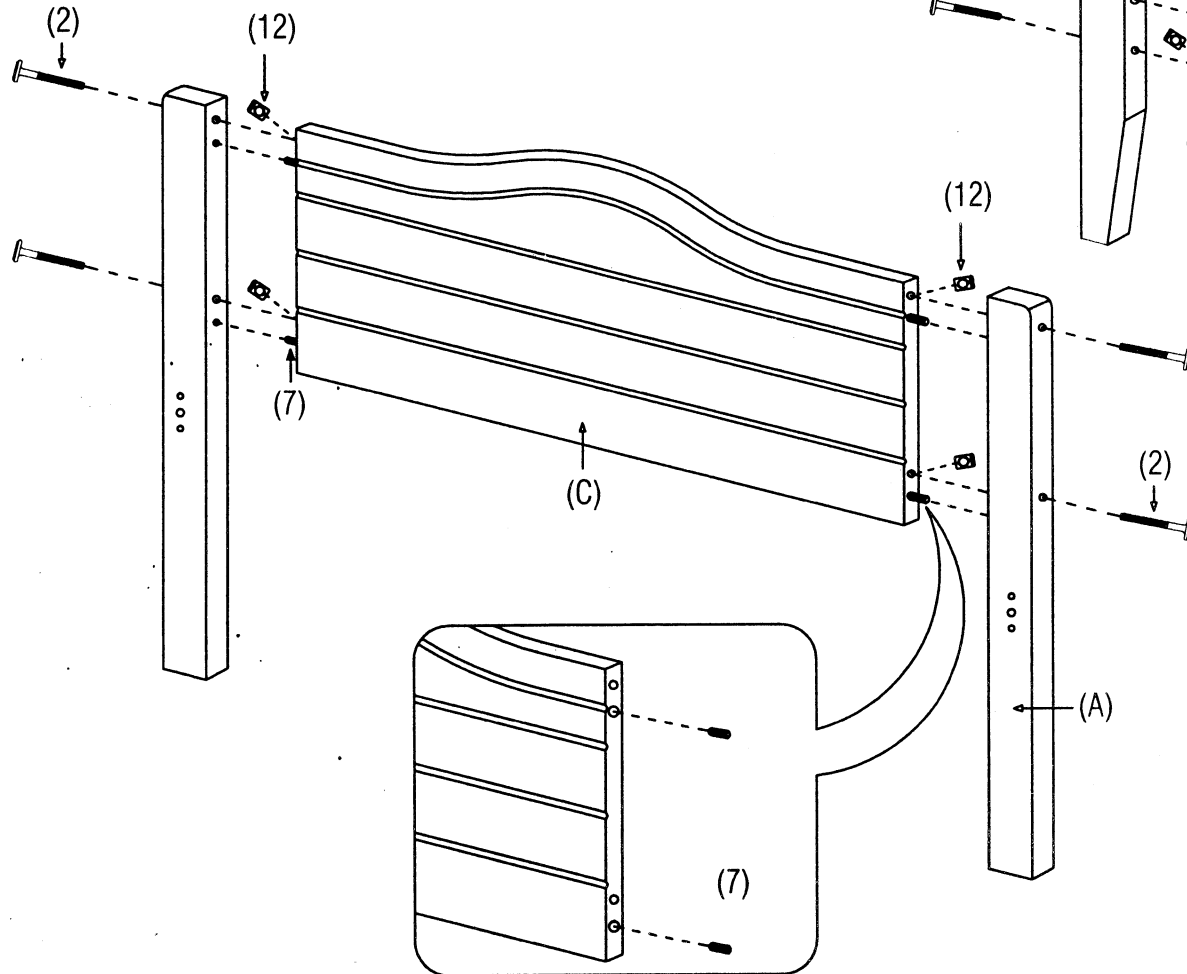
2.	JCBC M6 x 100mm		x 4
12.	M6 x 13mm (Short) Barrel Nut		x 4
7.	Wood Dowel M10 x 40mm		x 4



2 Assemble the Foot Post (B) to the Fb. Panel (D).

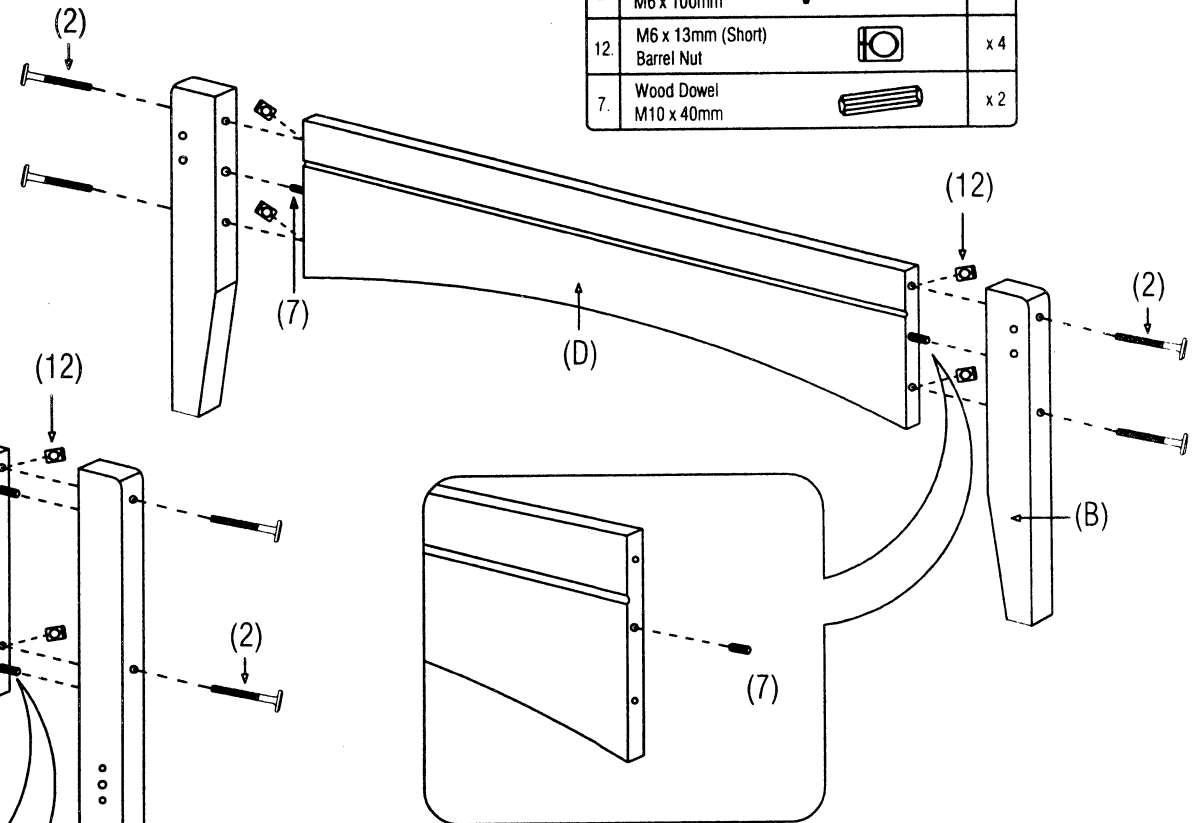

2.	JCBC M6 x 100mm		x 4
12.	M6 x 13mm (Short) Barrel Nut		x 4
7.	Wood Dowel M10 x 40mm		x 2







Assembly Instructions

Lauren Twin & Double Bed

3 Attach the Side Rails (E) to the Headboard and Footboard.

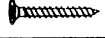
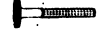
1.	JCBC M6 x 70mm		x 8
6.	M6 x 15mm (Long) Barrel Nut		x 8
7.	Wood Dowel M10 x 40mm		x 4

4 Lock the Support Legs (G) on Slats (H) & Center Rail (F). Please Note that the Hex Nut or Support Legs (G) have Adjuster at Bottom. Unscrew to Adjust if necessary.
Assemble the Slats (H) in the place.

8.	CSK M4 x 25mm		x 24
3.	JCBC M6 x 65mm		x 4
4.	JCBC M6 x 45mm		x 2
9.	M6 Hex . Nut		x 2
10.	Flat Washer		x 2
11.	Adjustable Screw		x 4

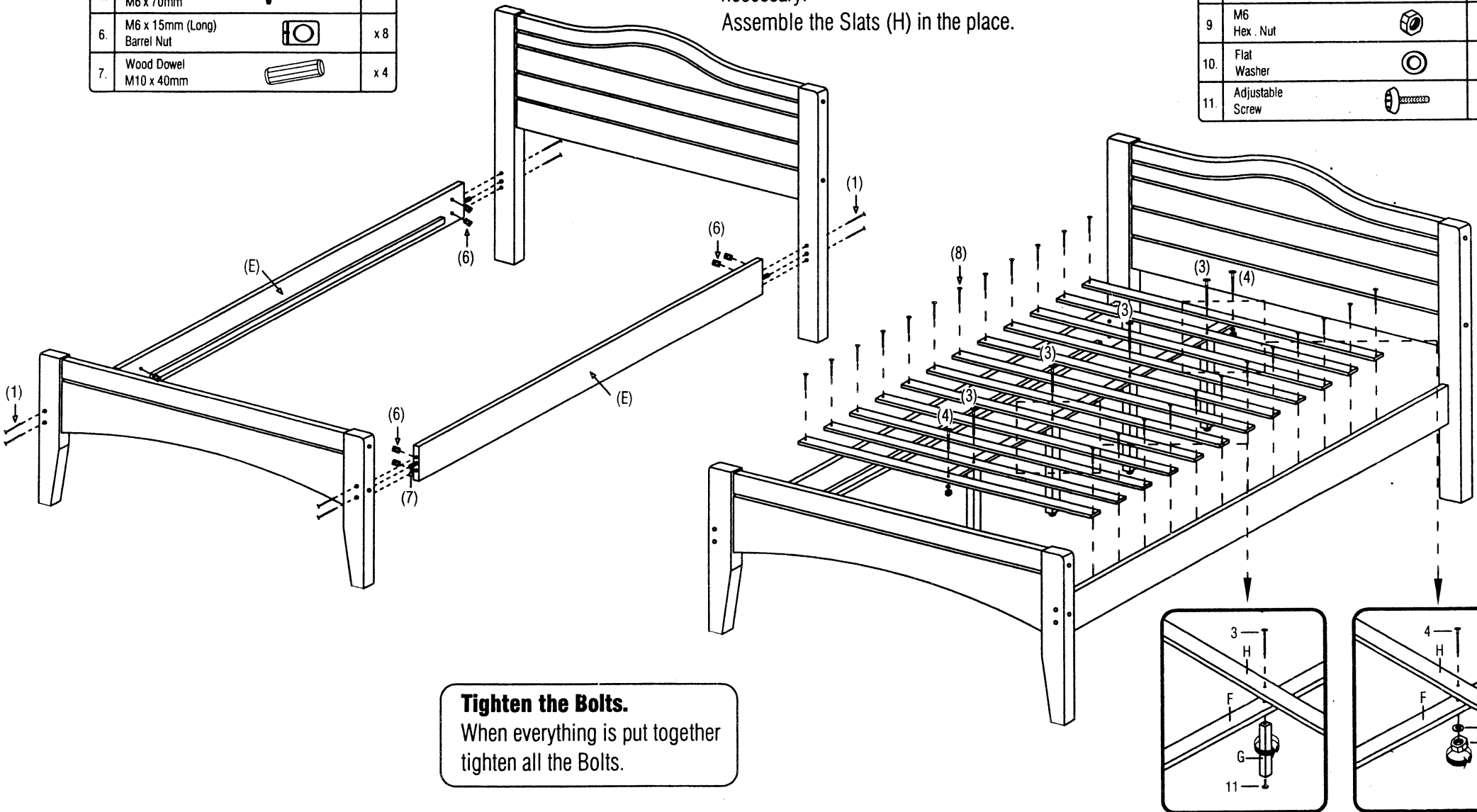

Tighten the Bolts.
When everything is put together
tighten all the Bolts.

Please dispose of all packaging safely.

General Care & Maintenance

Wipe clean with a slightly damp cloth.
Avoid the use of all household cleaners and abrasives.

Periodically check all screw & fixings to ensure they are secure.

When moving your product, carefully lift into place. Never drag or push the product across the floor as this will cause damage to the joints. If the product is used on hard flooring, such as wood or laminated floor, you must place some protection under the legs to stop the product from moving. If this is not adhered to, it could result in failure to the product that will invalidate the warranty.

For more information on cleaning and product care visit:
<https://www.happybeds.co.uk/help-and-advice>

Notes

In the unlikely event that you have problems putting this product together or have damaged or missing parts, please contact us by visiting:
<https://www.happybeds.co.uk/customer-service>