



Assembly Instructions

Important before assembly:

Read these instructions carefully before assembling or using the product.

Please check the contents of the boxes before attempting to assemble this product. The instructions will have a checklist of parts and fittings.

Assemble the product as close to its intended final location/room as possible.

Health & Safety:

This product or some parts of this product will be heavy. Please use an assistant when lifting.

Please keep small parts out of reach of children.

Always use on a level, even surface.

DO NOT jump on the product or any of its parts.

DO NOT use this product if any parts are missing, damaged or worn.

DO NOT use this product unless all fixings are secured.

Further instructions are on the following pages.

Please keep these instructions for future reference.

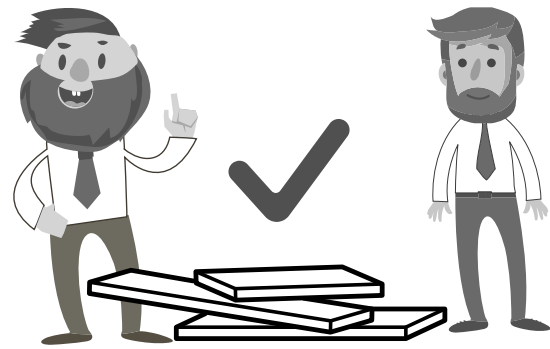
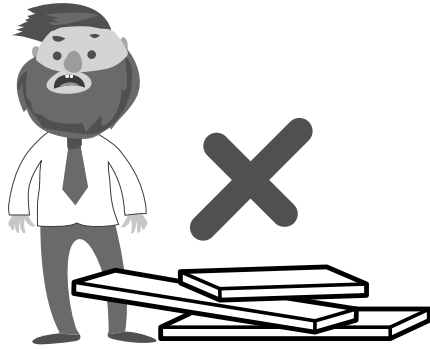

This product or some parts of this product will be heavy. Please use an assistant when lifting.

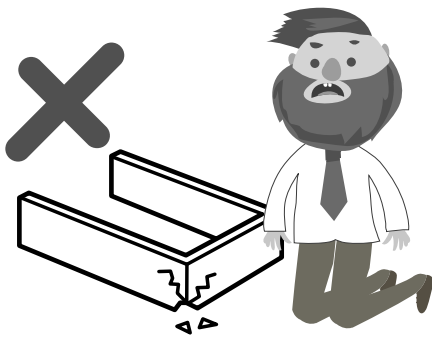

Never drag or push the pieces across a hard or stone floor as this will cause damage to the joints. Use a carpet or a rug for extra care.

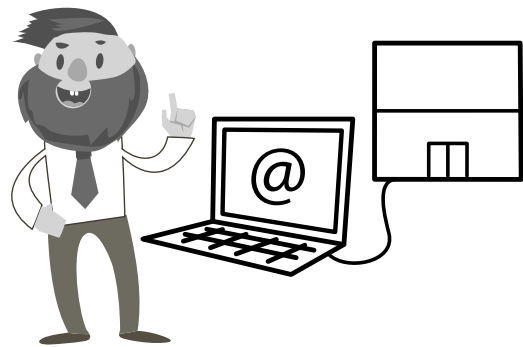
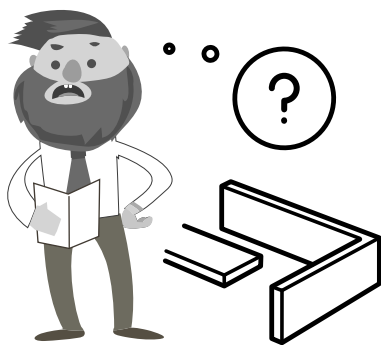

If you have problems assembling or have damaged or missing pieces, please contact our customer services (details at the back of these instructions)

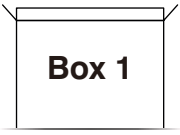

Box 1

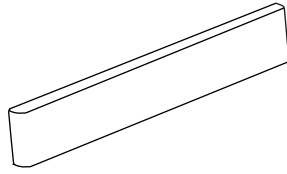

F. Footboard (x1)

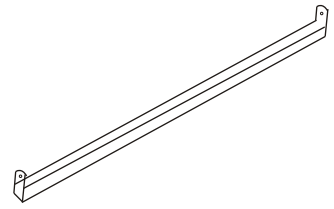

T. Bed Cross Bar(x4)

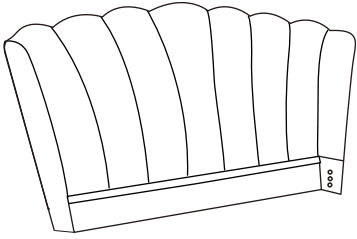

A.Headboard (x1)

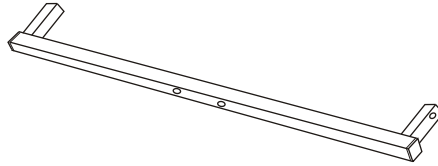

W.Front and Back Frame Rail(x2)

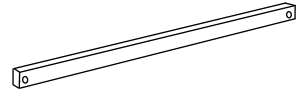

X.Cross Support Bar(x2)

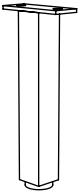

G. Support Leg (x1)



Q Slat Caps (x26)

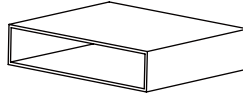

R. Centre Slat Caps (x13)

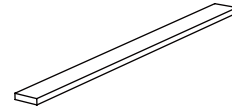

H.Slats(x26)



I. Legs (x4)

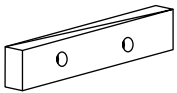

B1. Baton (x1)

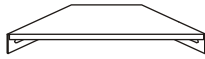

V. corner bracket (X2)

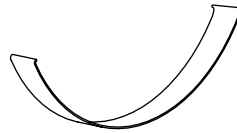

U. Pull Strap (x1)

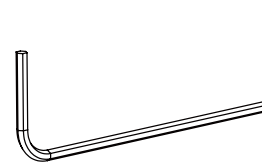

O. M5 Allen Key (x1)

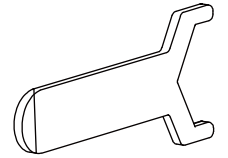

P. Spanner (x1)



C1. M4 Allen Key (x1)

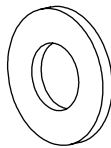

M. Flat Washer (X10)



N. Spring Washer (x10)

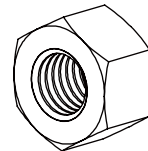

K. Nuts (x12)

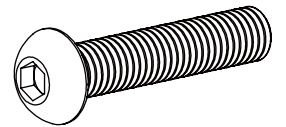

L. M8x45mm Bolts (x10)

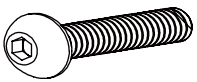

Y.M6x16mm Bolts (x12)

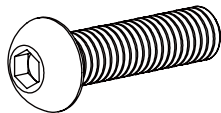

J. M8x30mm Bolts (x14)

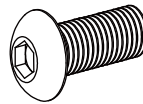

Z. M8x16mm Bolts (x4)

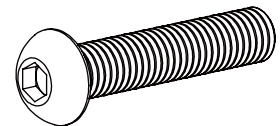

A1. M8x70mm Bolts (x4)



E.metal hook (X2)

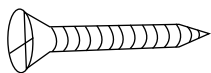

Z1.screw (x16)

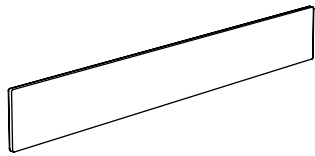
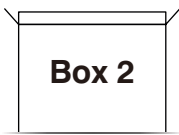

B. Side Rails (x2)

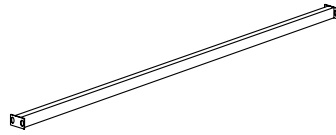

C. Centre Support Rail (x1)



D. Left & Right Frame Rail (x2)

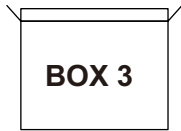

D1. Support Board (X2)

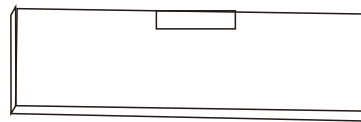

E1. Support Board (X2)

Step 1

Unpack all components from the boxes and check you are not missing anything. Please check these against the list on page 3 & 4. Should you identify any missing components, please contact the retailer you purchased the bed from.

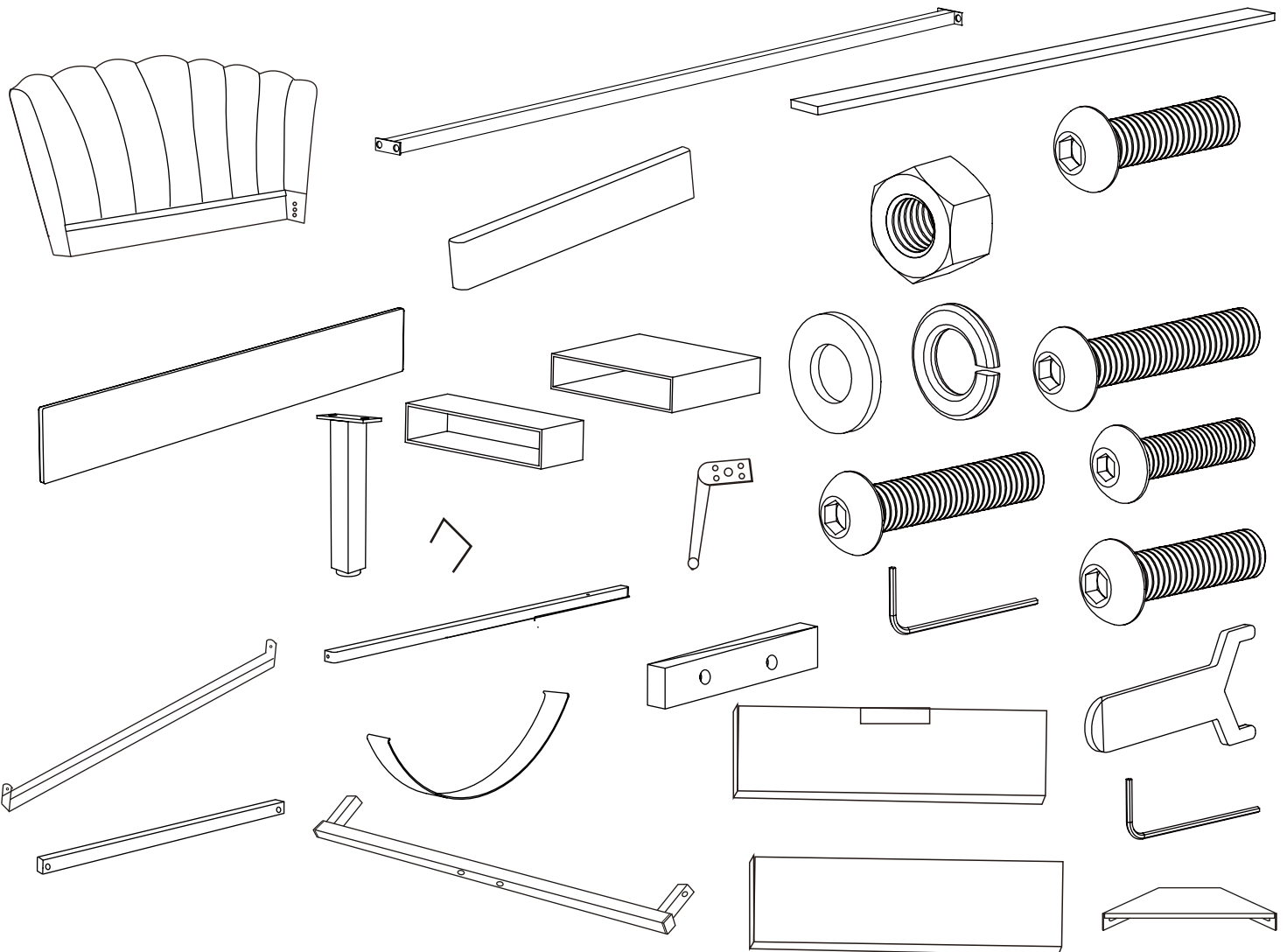

Step 2

Connect 2 legs (I) to 1 headboard (A) with 2 M8 bolts (J) and 8 screws (Z1), then connect 2 legs (I) to 1 footboard (F) with 2 M8 screws and 8 screws.

Please do not use any power tools for this assembly as it will void your guarantee.

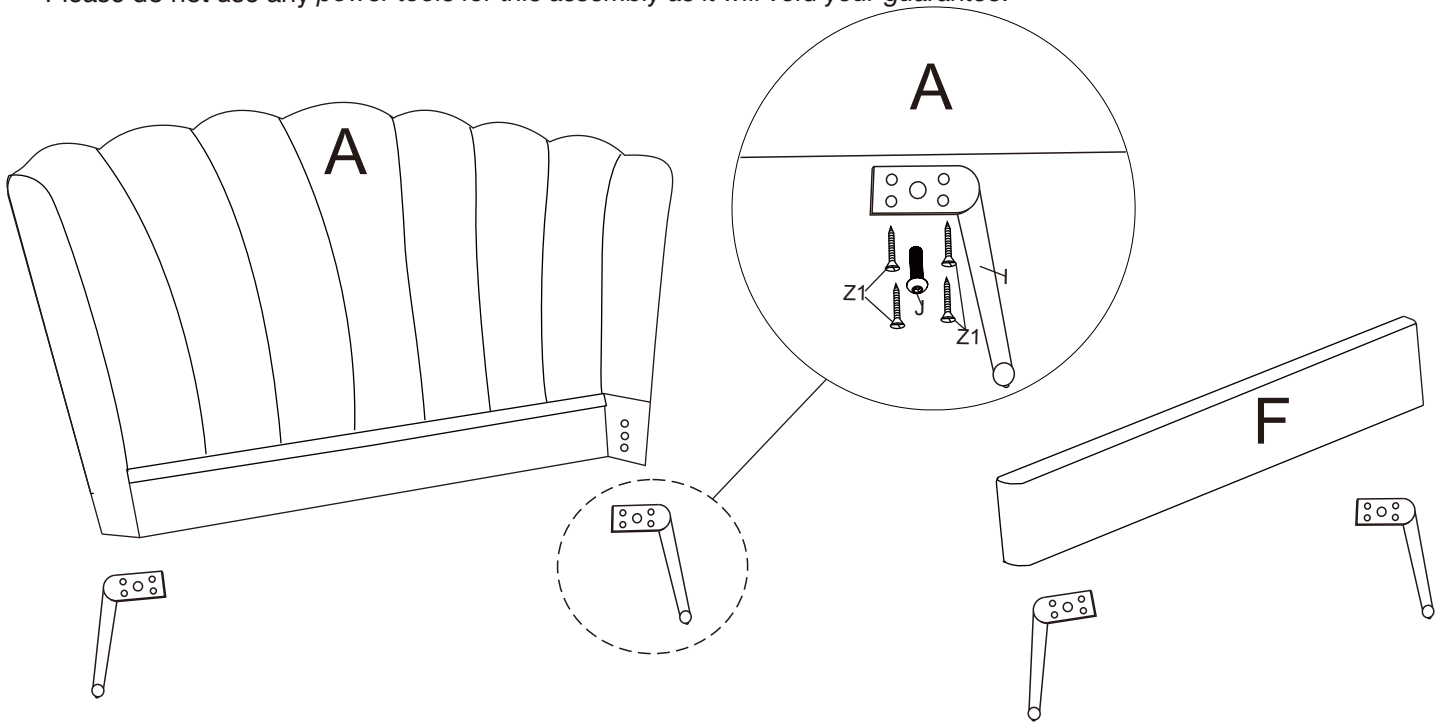

Step 3

Attach 2x Side Rails (B) to 1x Headboard (A) and 1x Footboard (F) using 10x M8x30mm Bolt (J), 10x Spring Washer (N), 10x Flat Washer (M) and 1x M5 Allen Key (O).

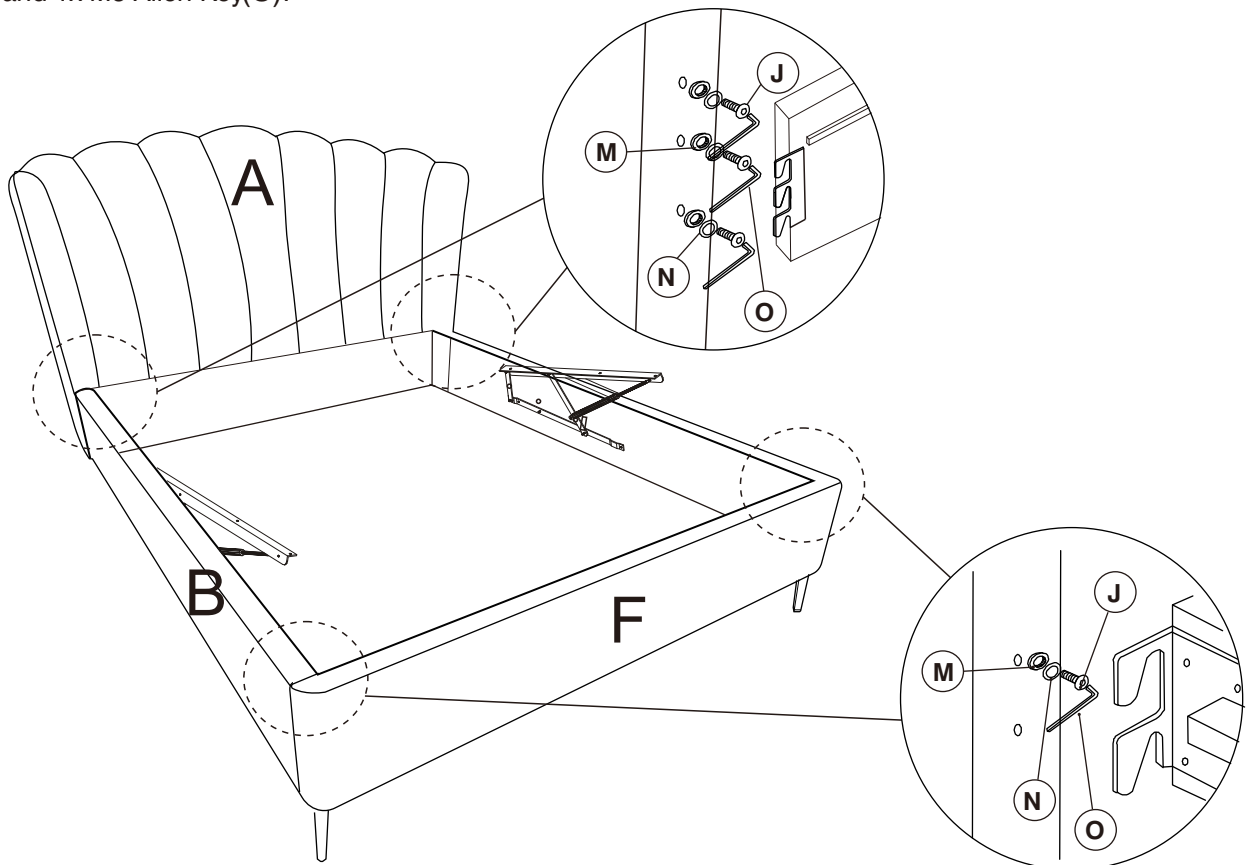

Step 4:

To attach the corner bracket (V) to the footboard (F) and side rails (B) you will need to use hardware parts 4X M6x16mm Bolts (Y) and the M4 allen key (C1).

To fix the 4 X bed cross bar (T) to the side rails, you will need to use hardware 8X M6x16mm Bolts (Y) and the M4 allen key (C1).

DO NOT use any power tools as this may damage the bed frame and will invalidate any claims.

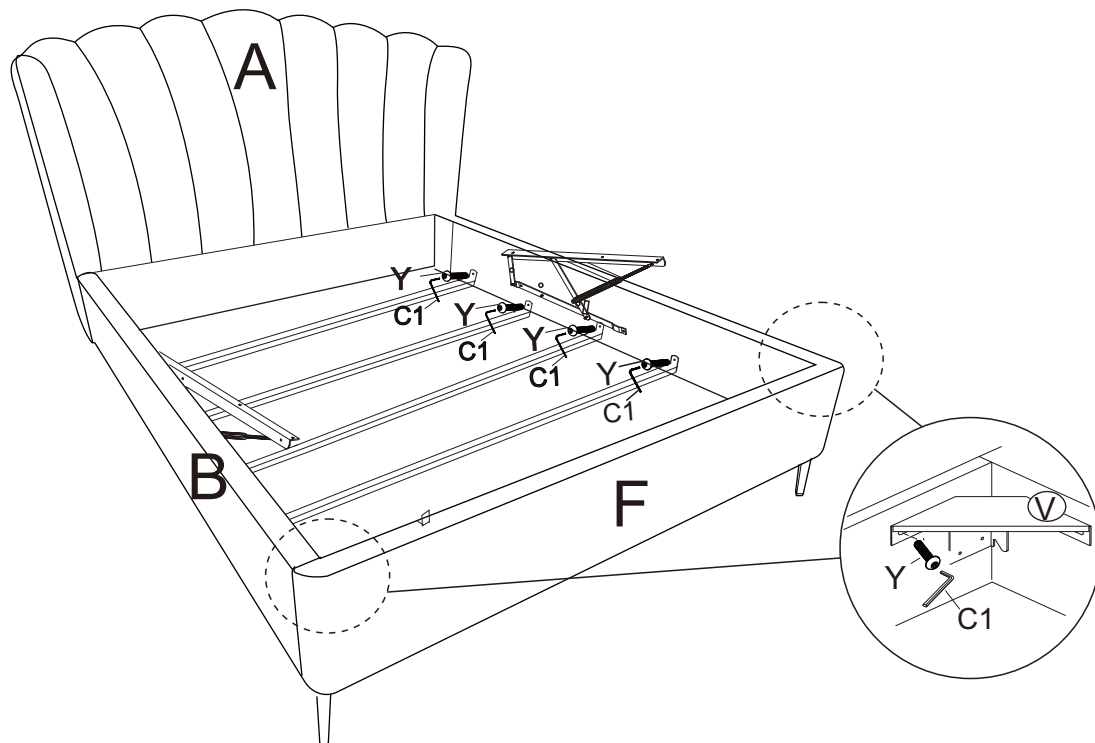

Step 5:

Fix Support Boards 2X(D1) and 2X(E1) to above the Bed Cross Bars (T)

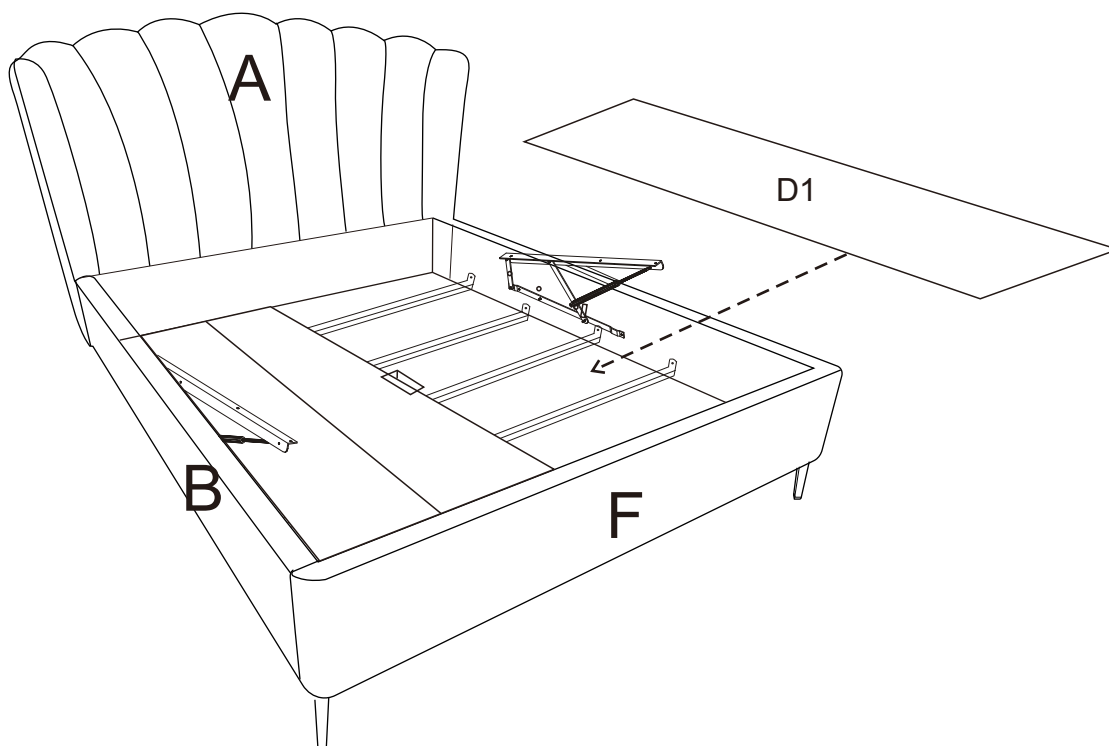

Step 6

To attach the front frame rail(W)and back frame rail (W) to the left frame rail (D)and right frame rail(D), you will need hardware parts 4 X M8x16mm Bolts (Z) with the M5 allen key(O).

To attach the centre support bar (C) to the front frame rail(W)and back frame rail(W),you will need hardware parts 4X M8x45mm Bolts(L) and 4X Nuts (K) with the M5 allen key(O) and the spanner(P).

To attach the support leg (G) to the centre support bar(C),you will need hardware parts 2X M8x45mm Bolts(L) and 2X Nuts (K) with the M5 allen key(O) and the spanner(P).

Insert the metal hook(E) to the front frame rail(W).

DO NOT use any power tools, this may damage the bed frame and will invalidate any claims.

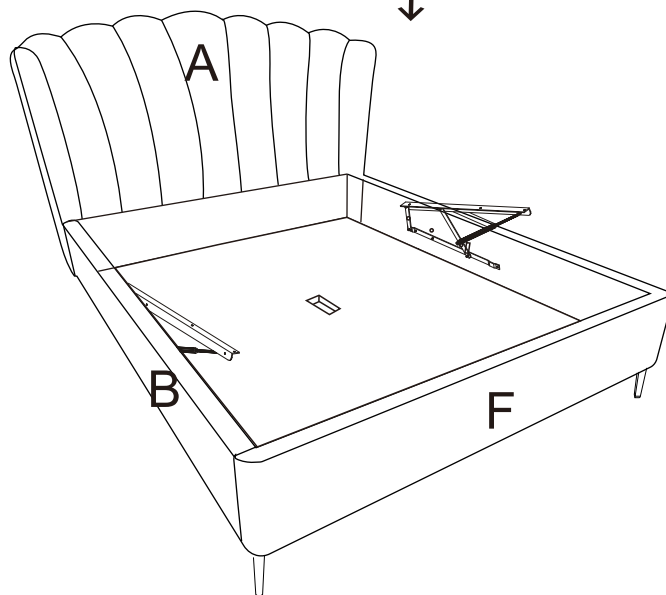
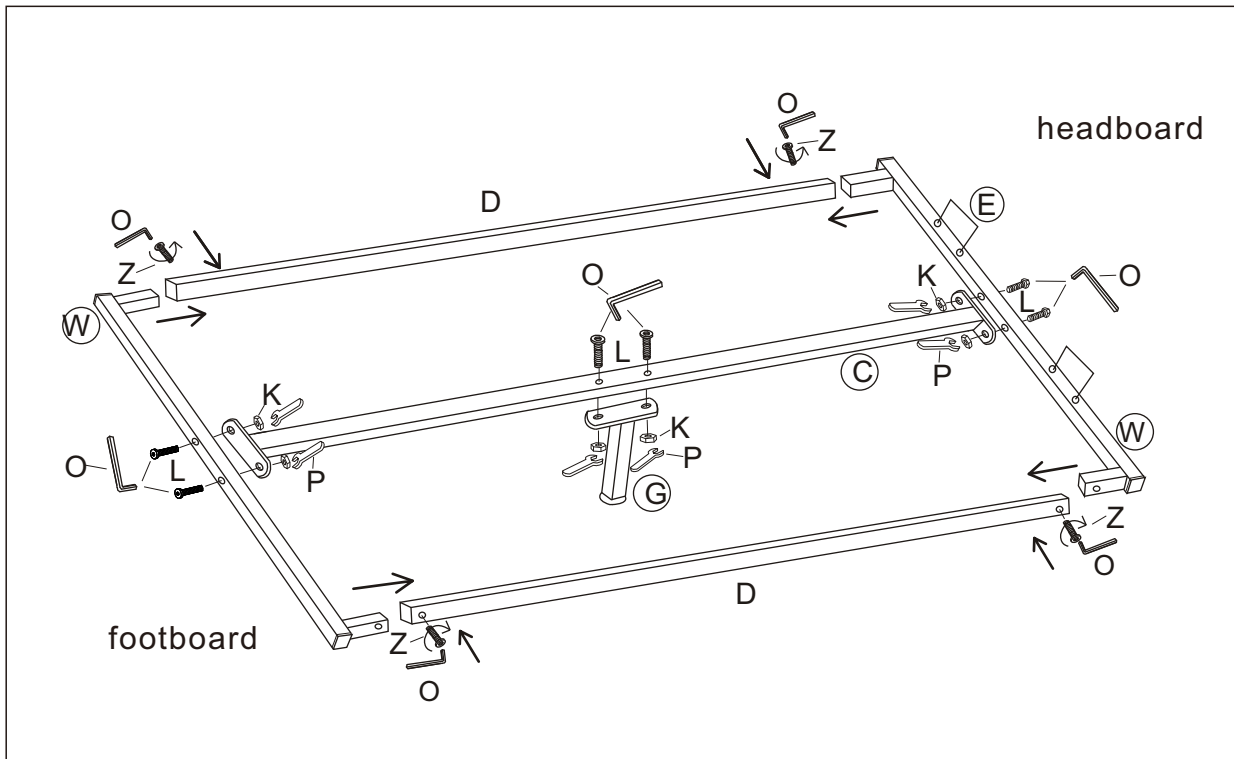

Step 7

To attach the metal frame(W/C/D) and cross support bar(X)to the gas lift pre-fixed to the side rails, you will need to use hardware parts 4X M8x70mm Bolts(A1) , 2 XM8x45mm Bolts(L) and 6x Nuts (K) with the M5 allen key(O) and the spanner(P).

To attach the Baton (B1)TO the footboard(F) you will need to use hardware parts 2xM8x45mm Bolts (L) with the M5 allen key(O) .

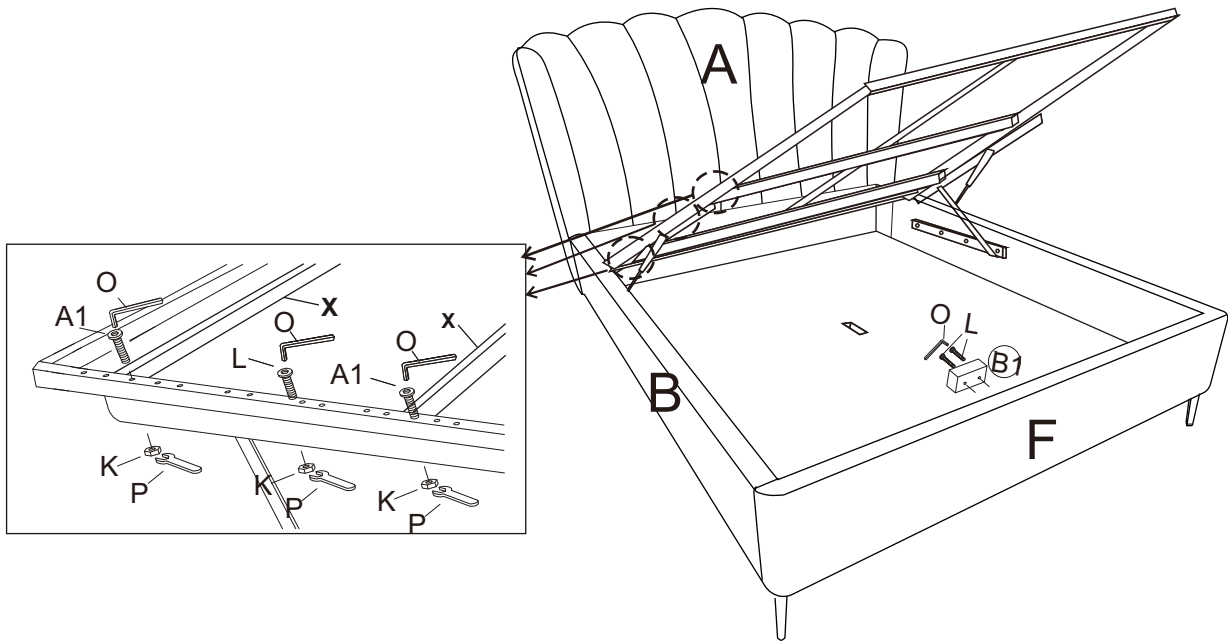

Step 8

Slot each Slat Cap (Q) onto the end of each Slat (H), then slot each Slat (H) into each Centre Slat Cap (R). Press firmly into each slat rail located on the inside of the side rails (B) and then into the Centre Support Rail (C).

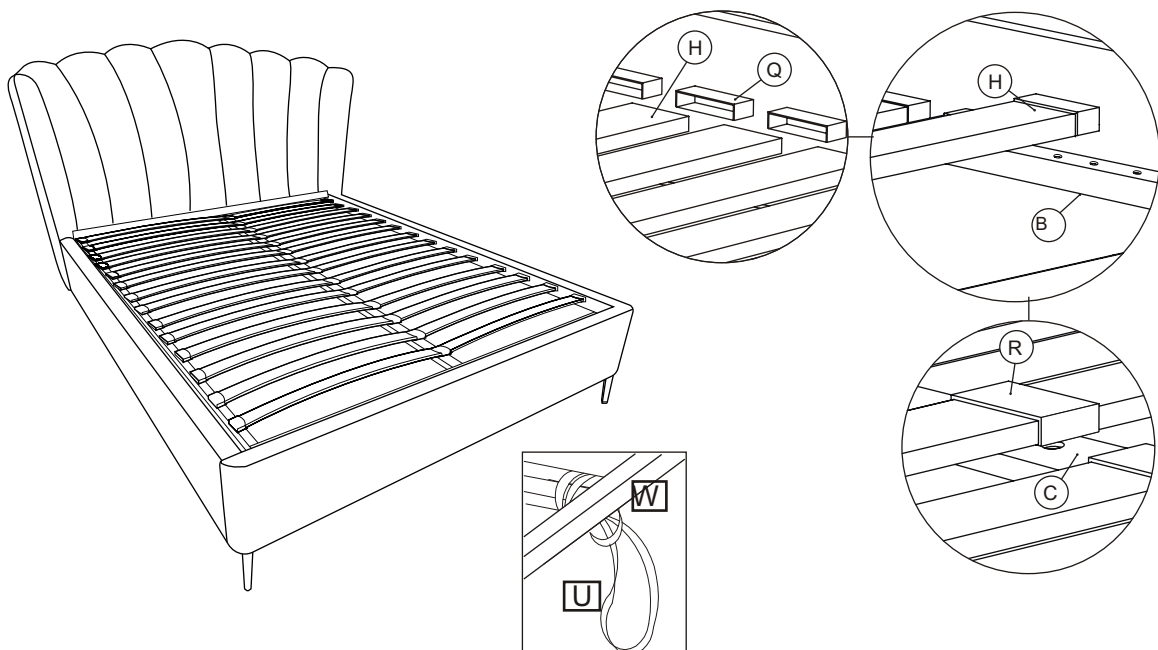

Important for Ottoman and other gas lift beds

Please follow these final steps to ensure the best experience with your new bed

- Please ensure the pistons are fitted to the bed frame.
- Please place the mattress on top of the bed frame.
- Standing at the foot of the frame (looking at the headboard) open the base and the press quite forcefully down on the mattress - please do not attempt to do this without the mattress being in place.
- Please do not pull on the strap handles.
- Please note as the pistons are full of gas - you will need to press heavily to release the compressed gas.
- Once done the pistons should start operating as normal.



Please dispose of all packaging safely.

General Care & Maintenance

Wipe clean with a slightly damp cloth.
Avoid the use of all household cleaners and abrasives.

Periodically check all screw & fixings to ensure they are secure.

When moving your product, carefully lift into place. Never drag or push the product across the floor as this will cause damage to the joints. If the product is used on hard flooring, such as wood or laminated floor, you must place some protection under the legs to stop the product from moving. If this is not adhered to, it could result in failure to the product that will invalidate the warranty.

For more information on cleaning and product care visit:
<https://www.happybeds.co.uk/help-and-advice>

Notes

In the unlikely event that you have problems putting this product together or have damaged or missing parts, please contact us by visiting:
<https://www.happybeds.co.uk/customer-service>