



## Assembly Instructions

### Important before assembly:

Read these instructions carefully before assembling or using the product.

Please check the contents of the boxes before attempting to assemble this product. The instructions will have a checklist of parts and fittings.

Assemble the product as close to its intended final location/room as possible.

### Health & Safety:

This product or some parts of this product will be heavy. Please use an assistant when lifting.

Please keep small parts out of reach of children.

Always use on a level, even surface.

DO NOT jump on the product or any of its parts.

DO NOT use this product if any parts are missing, damaged or worn.

DO NOT use this product unless all fixings are secured.

**Further instructions are on the following pages.**

Please keep these instructions for future reference.

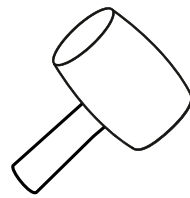

(Not metal)

These tools are not necessary, but may help to assemble certain parts of the product.

Do NOT use any power tools as this may damage the frame.

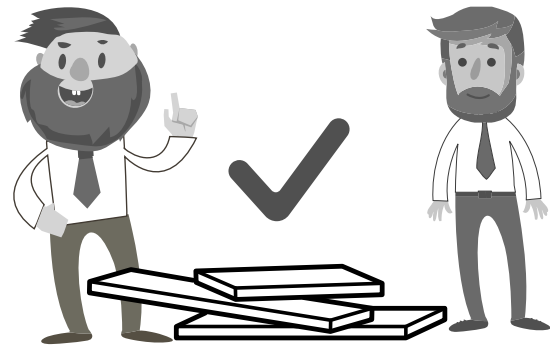
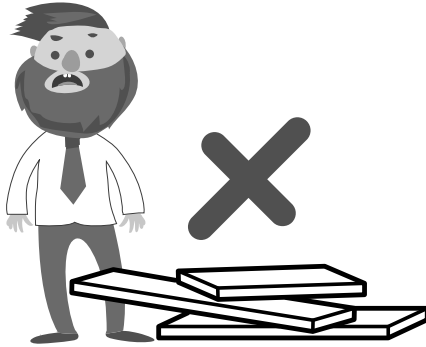

This product or some parts of this product will be heavy. Please use an assistant when lifting.

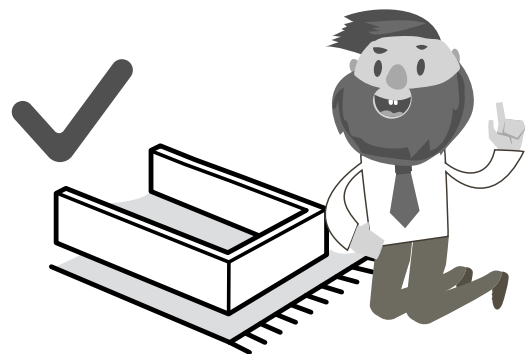

Never drag or push the pieces across a hard or stone floor as this will cause damage to the joints. Use a carpet or a rug for extra care.

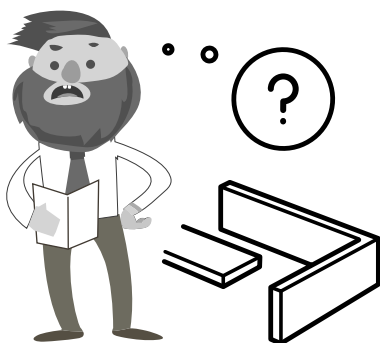

If you have problems assembling or have damaged or missing pieces, please contact us by visiting:

<https://www.happybeds.co.uk/customer-service>

PARTS

①

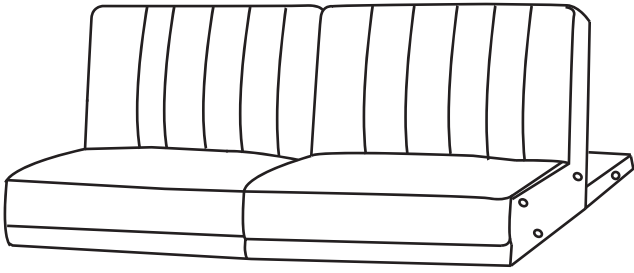

X1

②

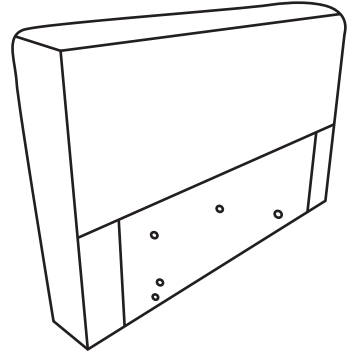

X1

③

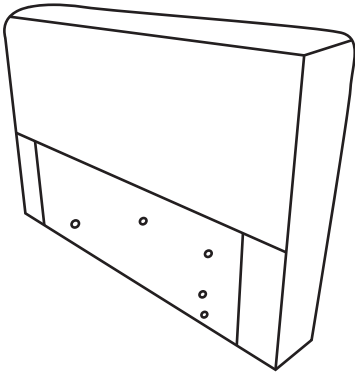

X1

④

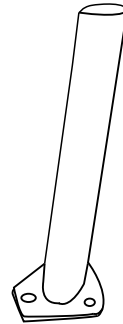

X4

⑤





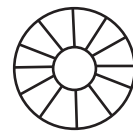

X1

⑥

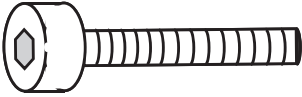

X1

# HARDWARE LIST

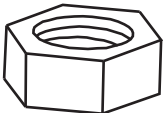
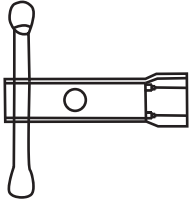
A		M8*30mm	12PCS
B		M8	1PCS
C		M8*80mm	8PCS
D		8*22*2mm	8PCS
E		M8	8PCS
F			1PCS

## **Safety Advice**

**Please take the time to carefully read through the whole of these instructions before you commence.**

Keep these instructions for future reference.

Unpack, inspect and check off all of the contents.

Please dispose of all packaging safely.

Small component parts could choke a child if swallowed.

We strongly recommend that you keep children well away from the work area.

It would be sensible to lay a sheet or blanket on the floor where you intend to work to avoid scratching this product and to protect your floor.

This product is heavy. Take extreme care when lifting to avoid personal injury or damage to the product.

Assemble the product as close to its intended final position in the room as possible.

**HANDY HINT:** If you keep the hardware in a bowl during assembly you will be less likely to lose them.

**Step 1**

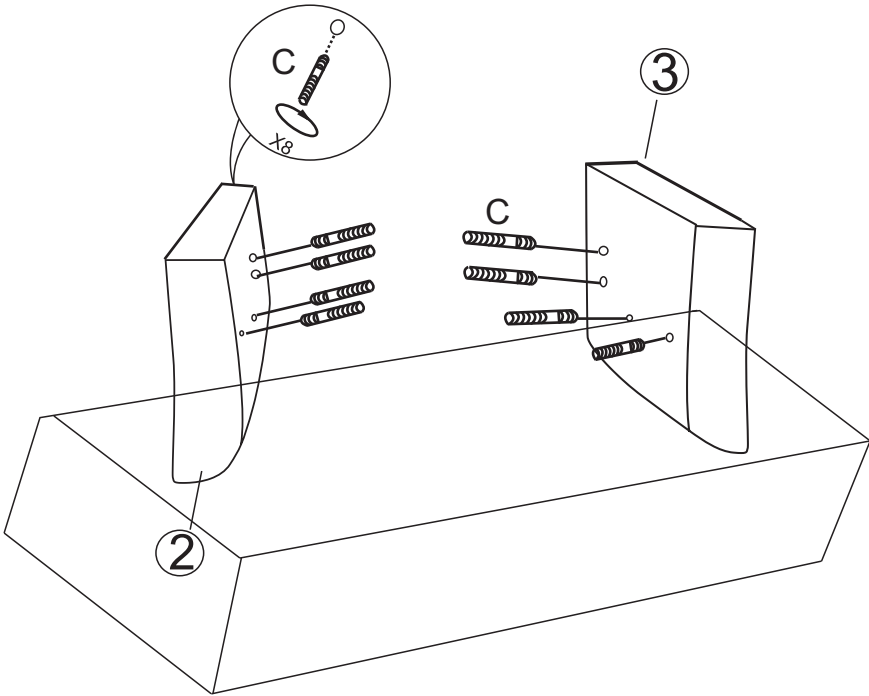

Step 2

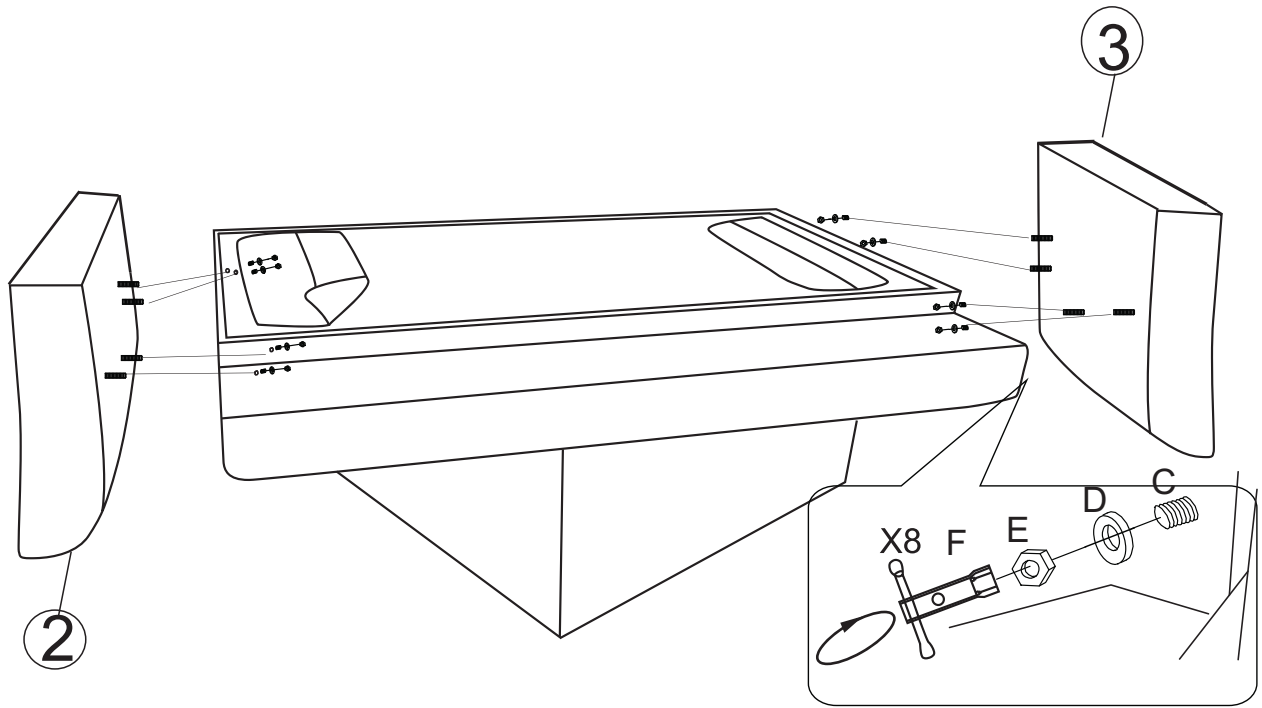

**Step 3**

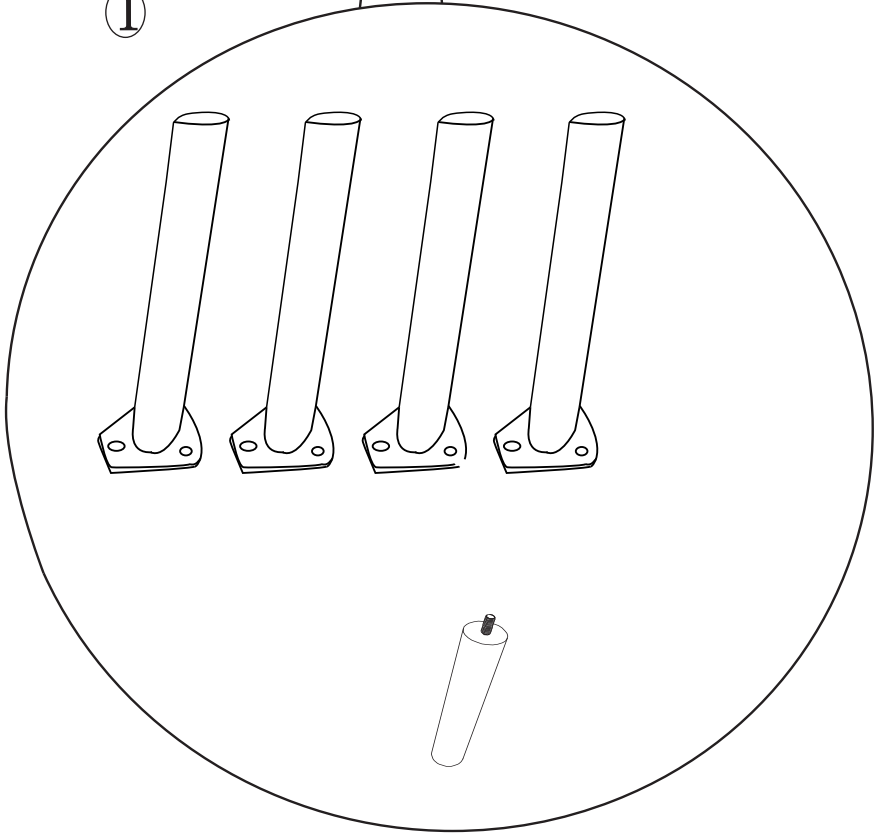
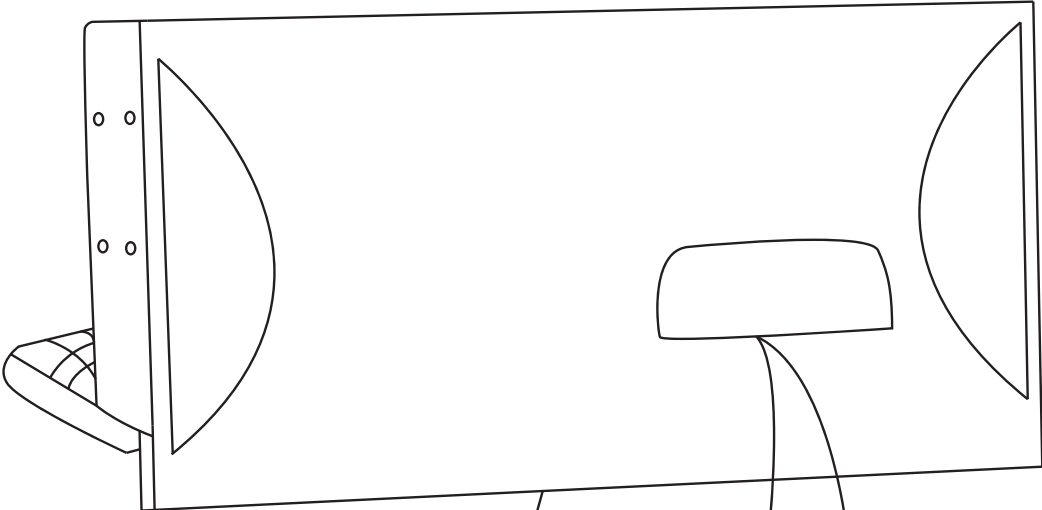



# Step 4

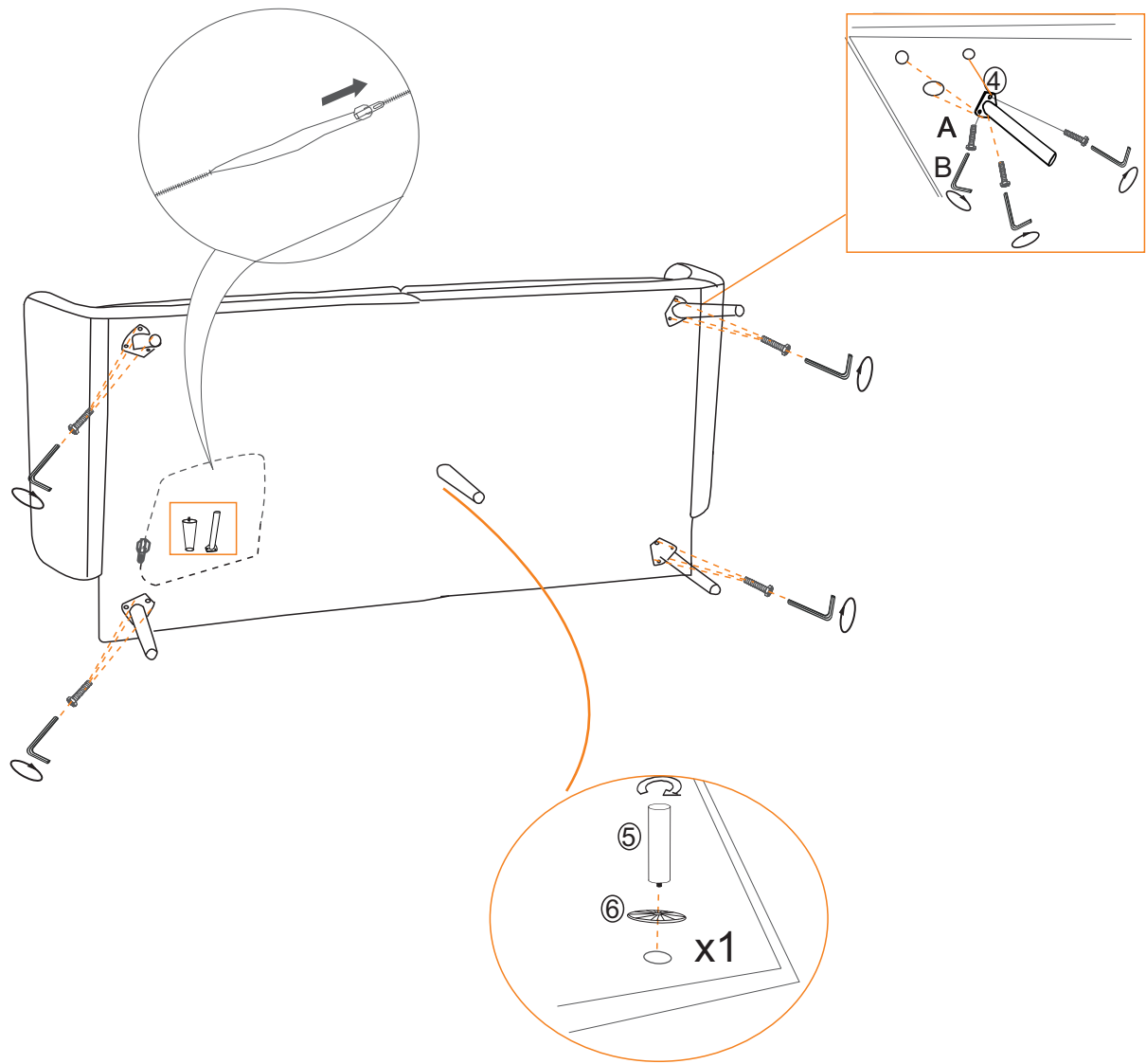

**Step 5**

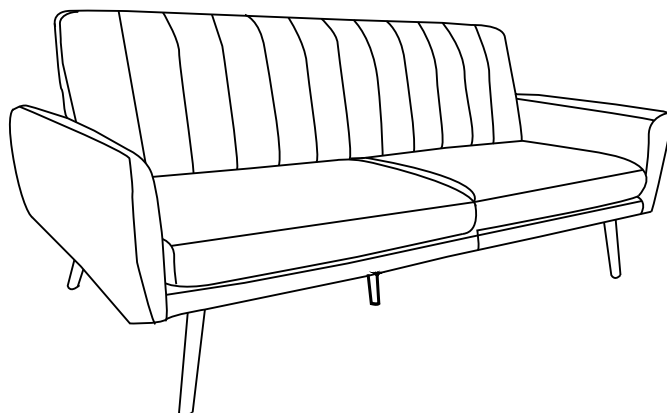
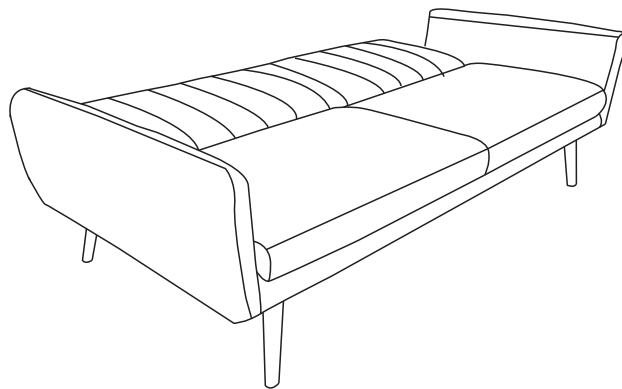
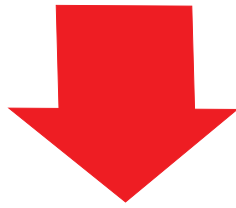
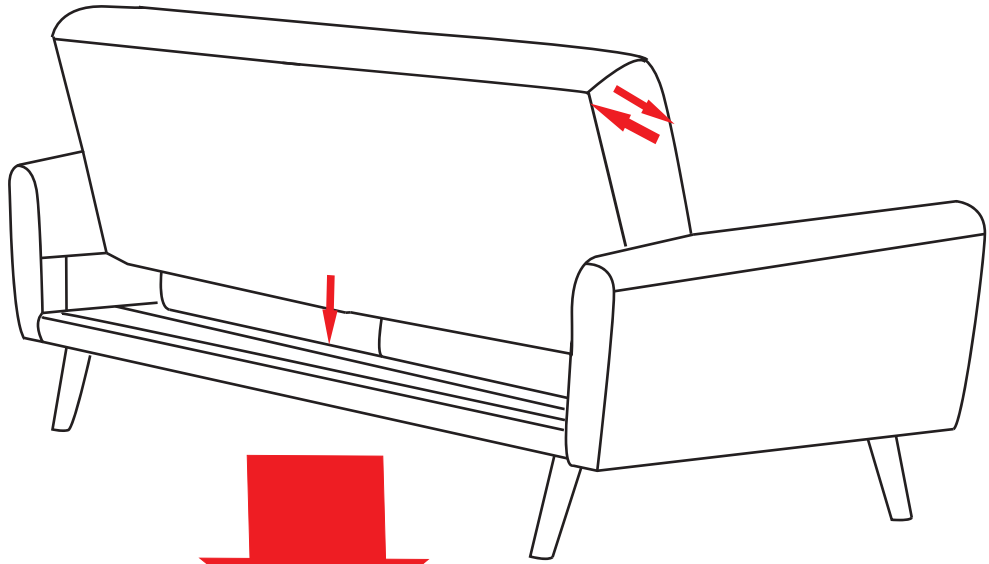

Please dispose of all packaging safely.

## General Care & Maintenance

Wipe clean with a slightly damp cloth.  
Avoid the use of all household cleaners and abrasives.

Periodically check all screw & fixings to ensure they are secure.

For more information on cleaning and product care visit:  
<https://www.makeithomely.co.uk/help-and-advice>

## Notes

In the unlikely event that you have problems putting this product together or have damaged or missing parts, please contact us by visiting:  
<https://www.makeithomely.co.uk/customer-service>

[www.makeithomely.co.uk](http://www.makeithomely.co.uk)

make it  
**homely**<sup>™</sup>  
by Happy beds<sup>™</sup>