



## Assembly Instructions

### Important before assembly:

Read these instructions carefully before assembling or using the product.

Please check the contents of the boxes before attempting to assemble this product. The instructions will have a checklist of parts and fittings.

Assemble the product as close to its intended final location/room as possible.

### Health & Safety:

This product or some parts of this product will be heavy. Please use an assistant when lifting.

Please keep small parts out of reach of children.

Always use on a level, even surface.

DO NOT jump on the product or any of its parts.

DO NOT use this product if any parts are missing, damaged or worn.

DO NOT use this product unless all fixings are secured.

**Further instructions are on the following pages.**

Please keep these instructions for future reference.

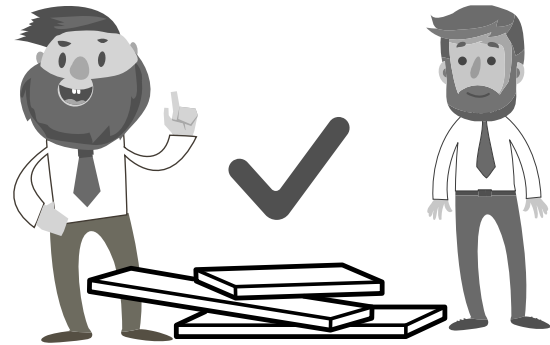
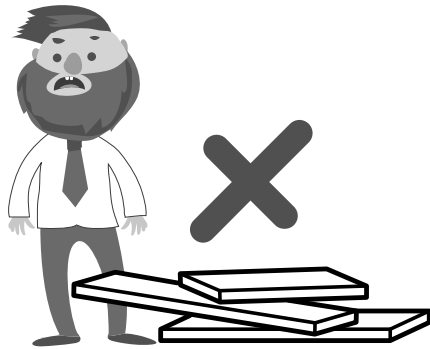
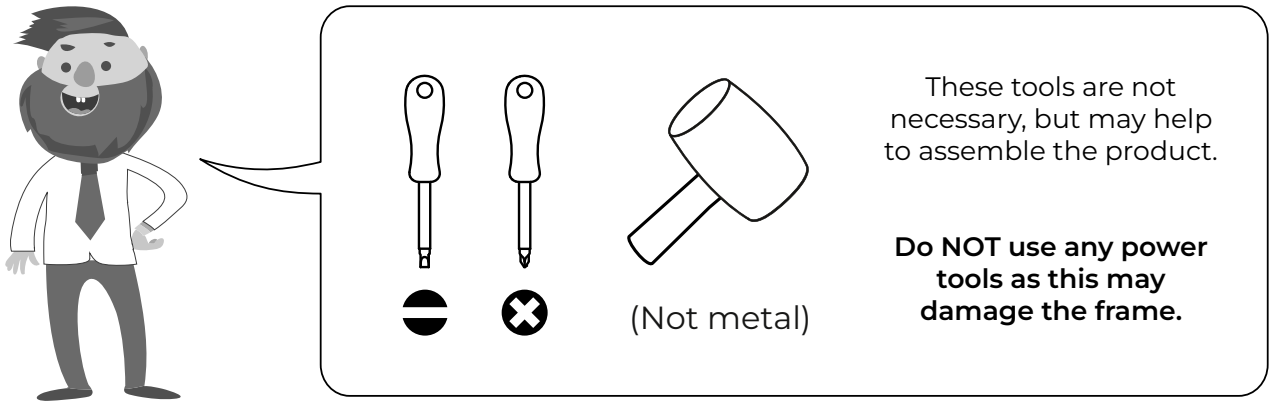

This product or some parts of this product will be heavy. Please use an assistant when lifting.

---

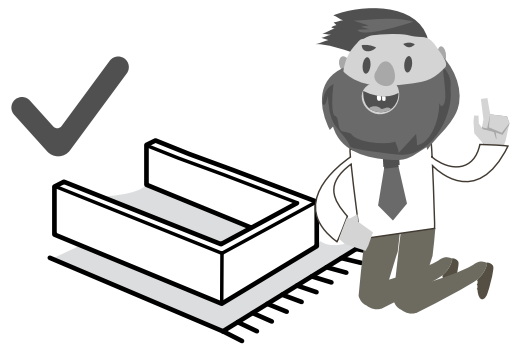
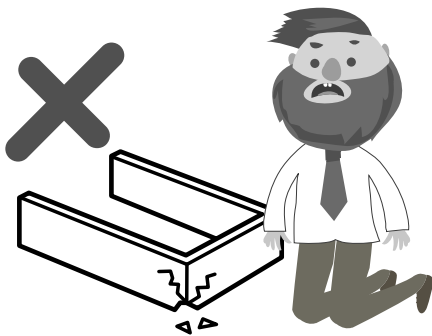

Never drag or push the pieces across a hard or stone floor as this will cause damage to the joints. Use a carpet or a rug for extra care.

---

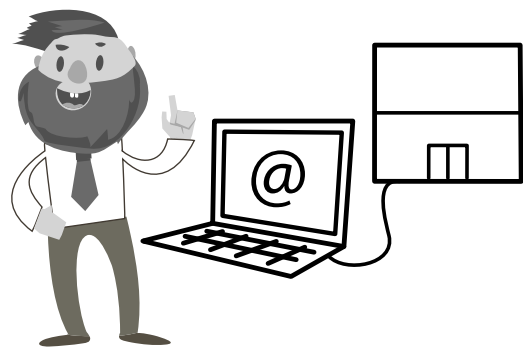
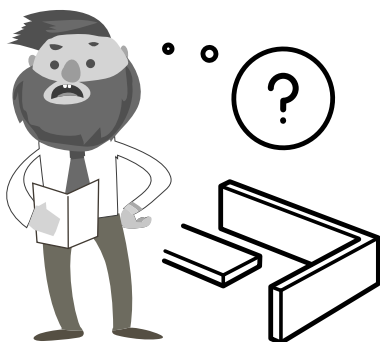

If you have problems assembling or have damaged or missing pieces, please contact our customer services (details at the back of these instructions)

Please check all hardware matches the list below. Should you notice any are missing please contact your retailer.

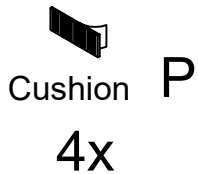
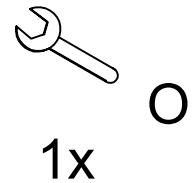
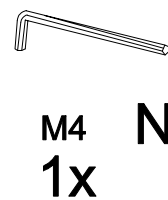
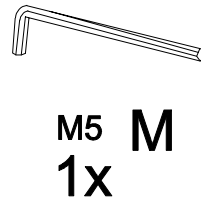
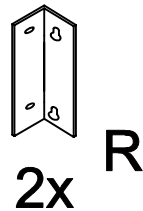
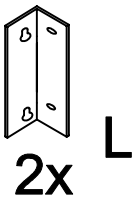
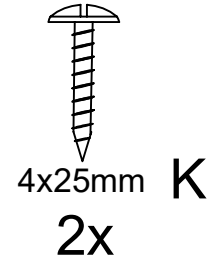
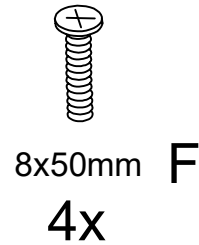
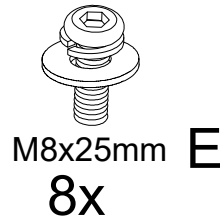
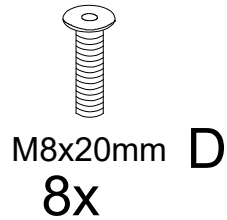
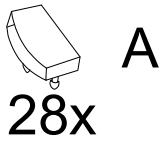

We strongly advise that you do not use Power Tools, such as drills or electric screwdrivers during the assembly as this may cause irreparable damage and will invalidate your warranty.



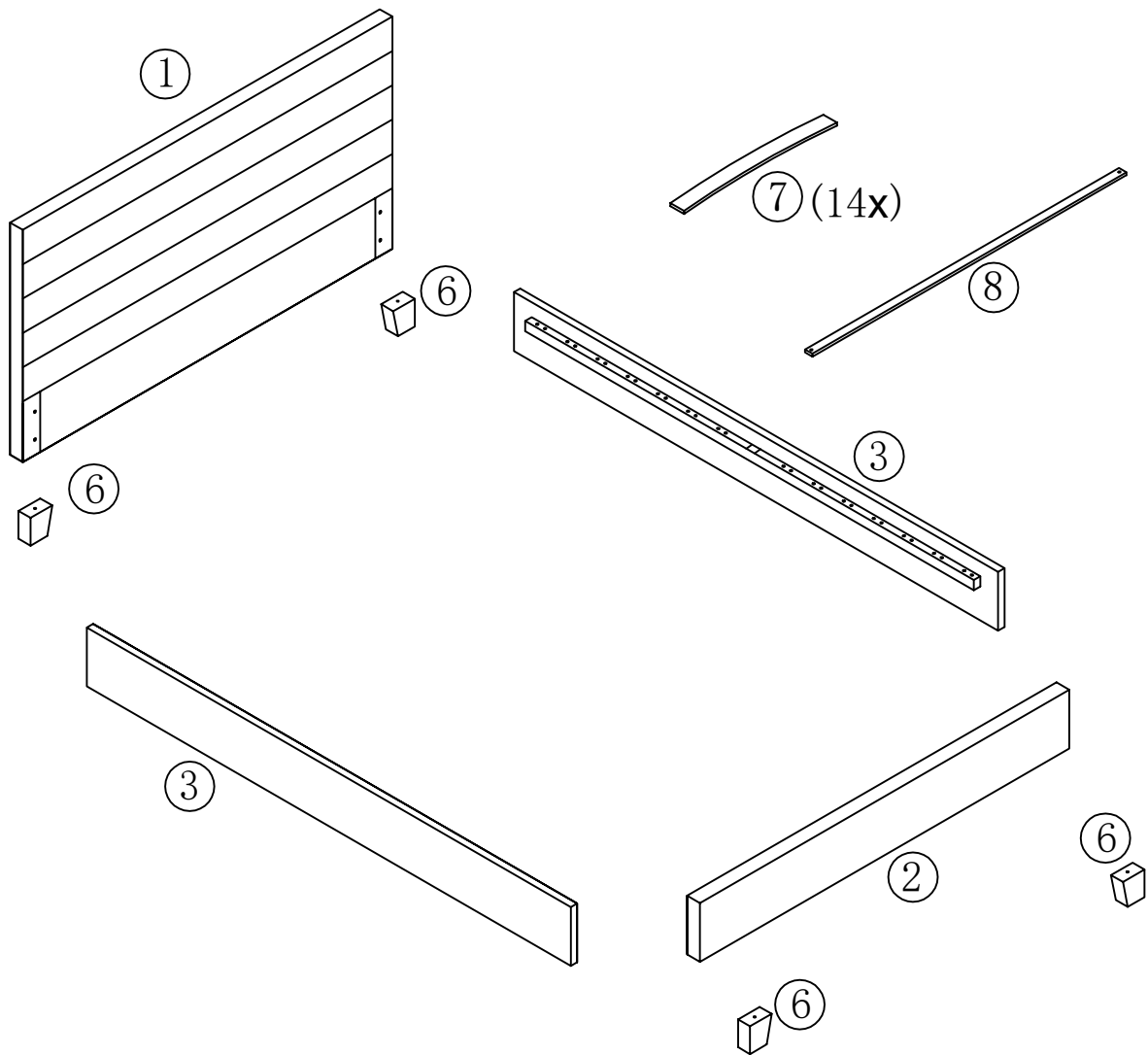

# PARTS





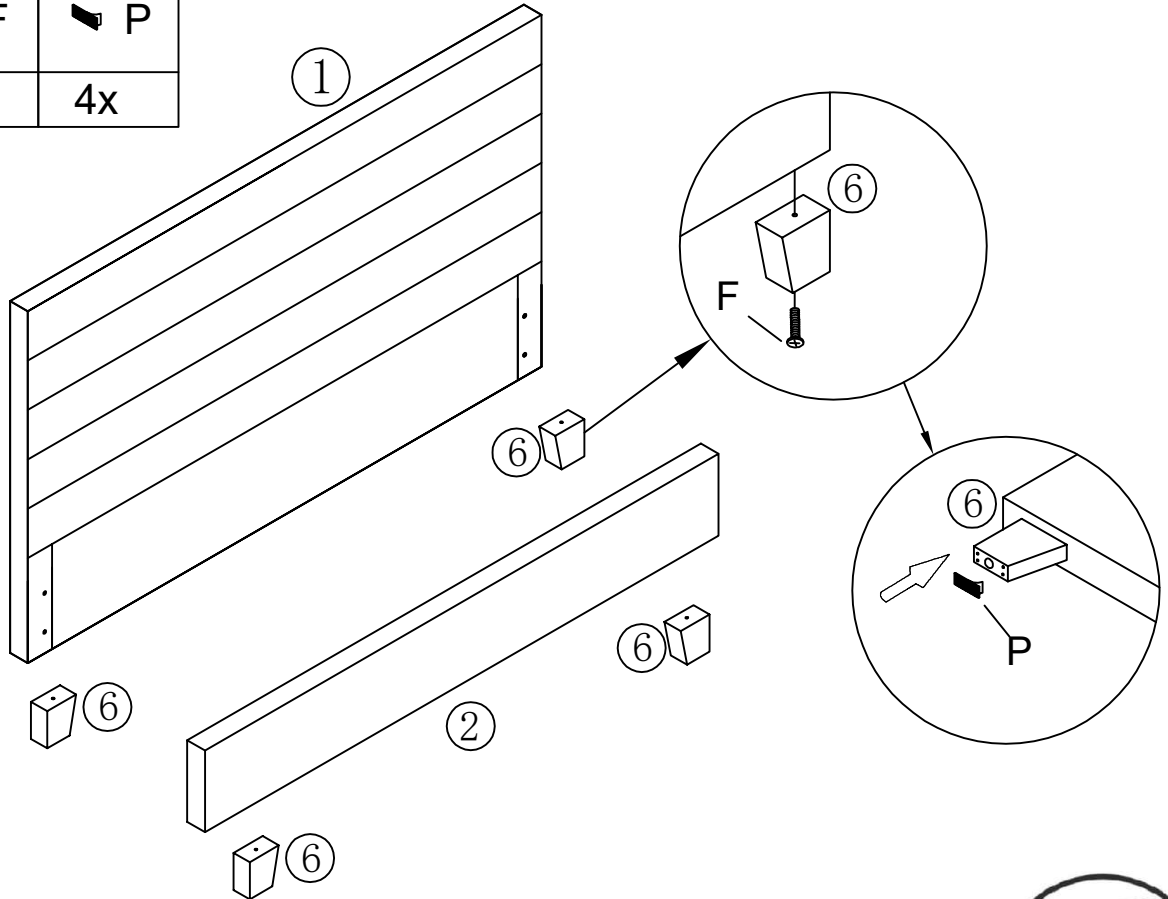

Please ensure you carefully check all the pieces, should you have any concerns please contact the retailer before assembly commences. Please have your order number, details of the issue, the product code, and the batch number from the cartons as this will help us to resolve your issue much faster.

# 1

8x50mm	Cushion
 F	 P
4x	4x



# 2

M8x25mm	M8x20mm		
 E	 D	 L	 R
8x	8x	2x	2x

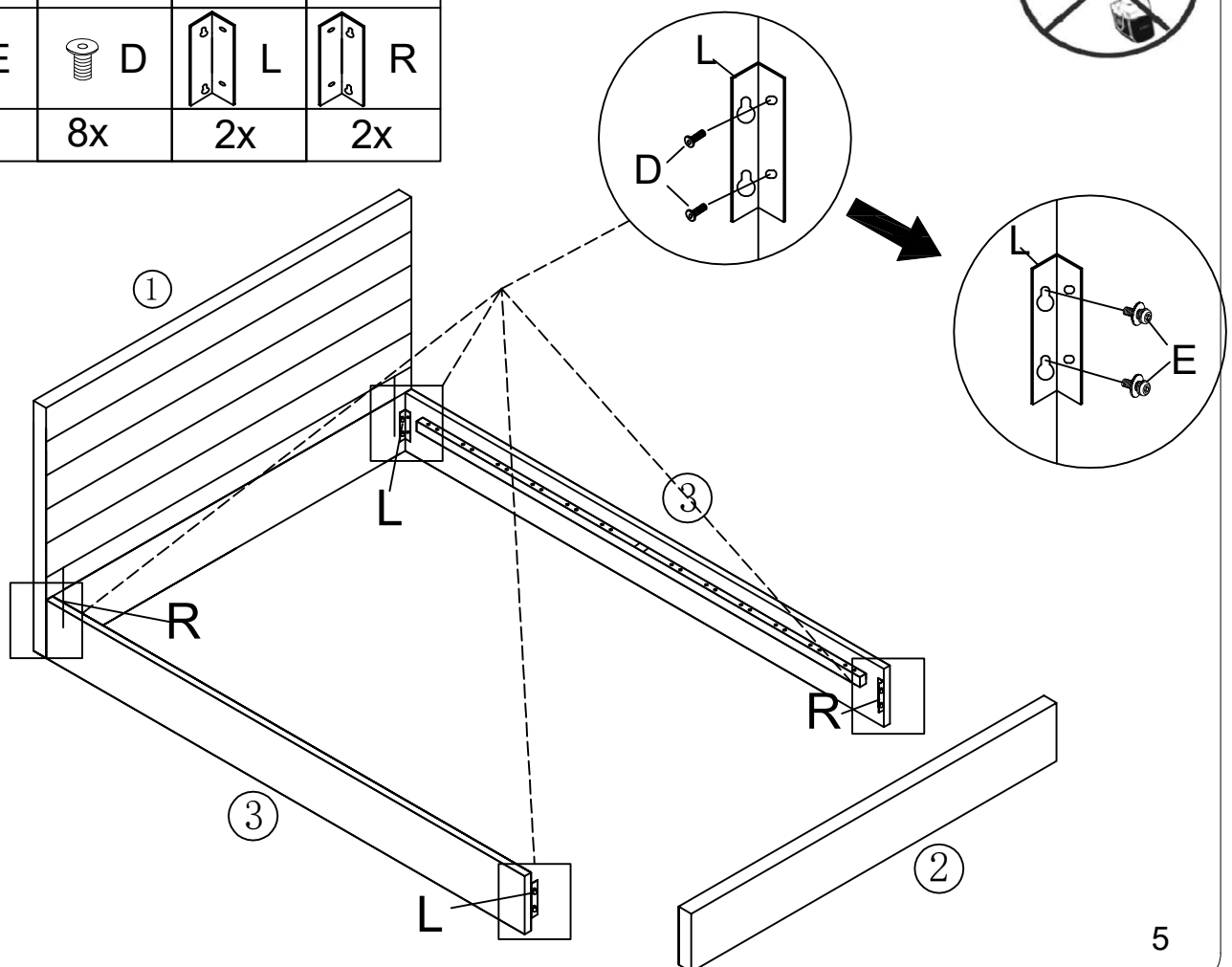

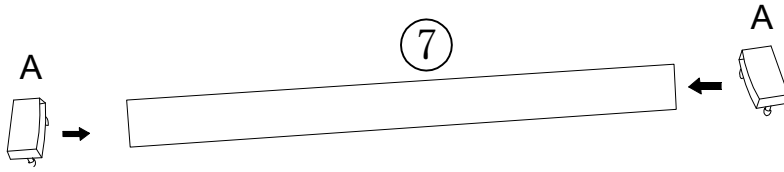
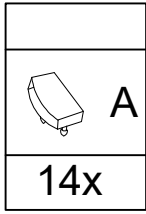

# 3

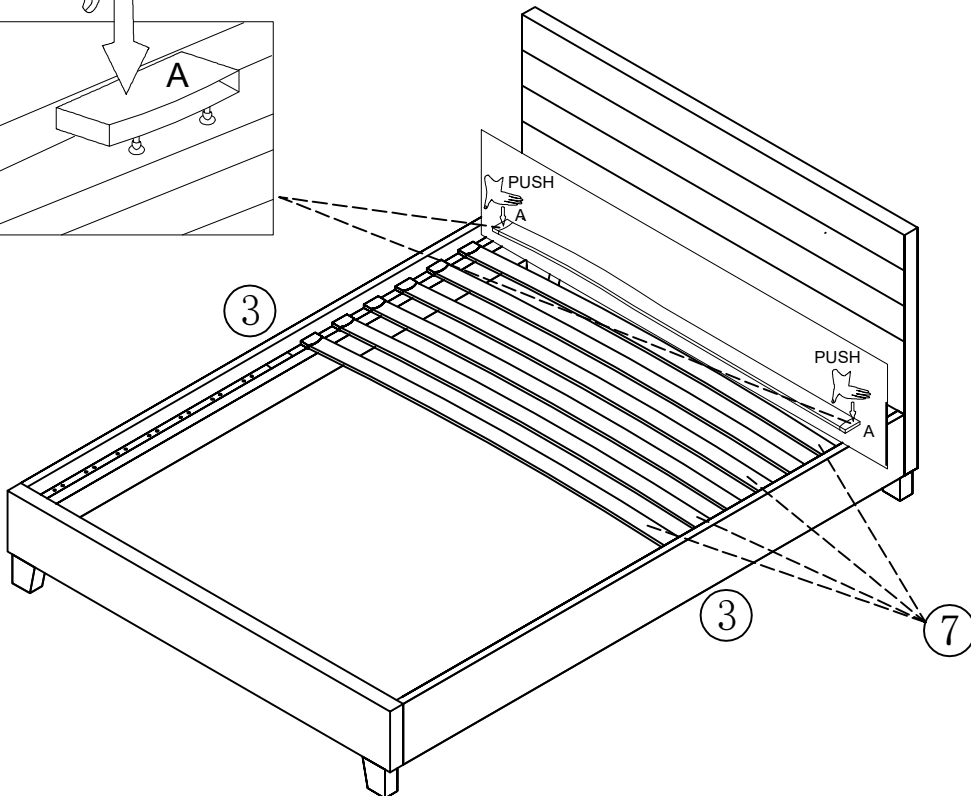
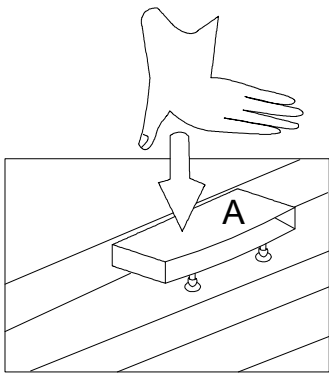

# 4



# 6

		4x25mm	
	A		K
14x		2x	

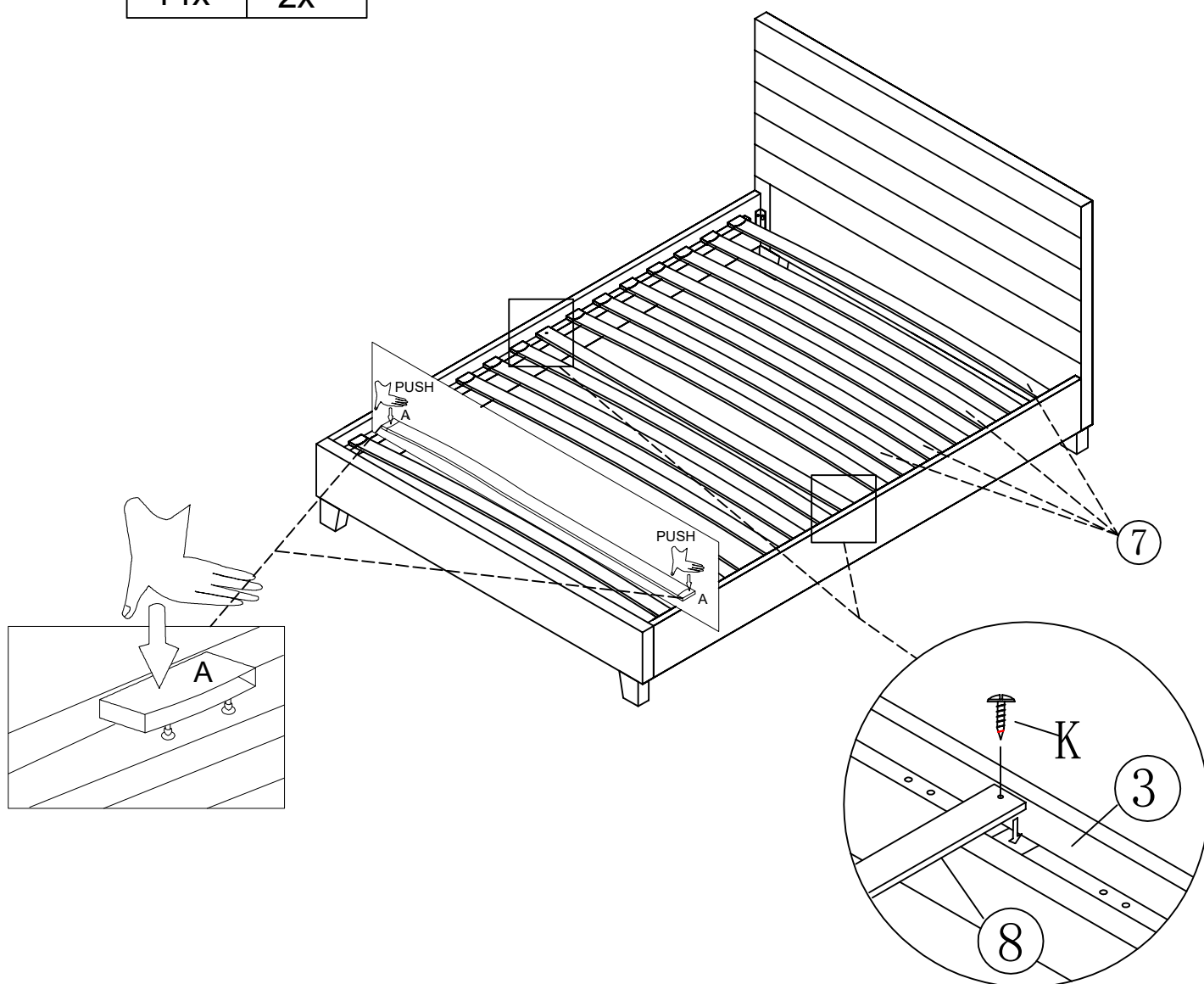

## GENERAL CARE & MAINTENANCE

We advise that when cleaning the product that a damp cloth is used.

Avoid the use of all household cleaners and abrasive.



Never push or drag the furniture.

Never attempt to move the furniture when fully loaded.

We advise that periodically all fixing are re-tightened.

Please dispose of all packaging safely.

## General Care & Maintenance

Wipe clean with a slightly damp cloth.  
Avoid the use of all household cleaners and abrasives.

Periodically check all screw & fixings to ensure they are secure.

When moving your product, carefully lift into place. Never drag or push the product across the floor as this will cause damage to the joints. If the product is used on hard flooring, such as wood or laminated floor, you must place some protection under the legs to stop the product from moving. If this is not adhered to, it could result in failure to the product that will invalidate the warranty.

For more information on cleaning and product care visit:  
<https://www.happybeds.co.uk/help-and-advice>

## Notes

In the unlikely event that you have problems putting this product together or have damaged or missing parts, please contact us by visiting:  
<https://www.happybeds.co.uk/customer-service>