

Assembly Instructions

Important before assembly:

Read these instructions carefully before assembling or using the product.

Please check the contents of the boxes before attempting to assemble this product. The instructions will have a checklist of parts and fittings.

Assemble the product as close to its intended final location/room as possible.

Health & Safety:

This product or some parts of this product will be heavy. Please use an assistant when lifting.

Please keep small parts out of reach of children.

Always use on a level, even surface.

DO NOT jump on the product or any of its parts.

DO NOT use this product if any parts are missing, damaged or worn.

DO NOT use this product unless all fixings are secured.

Further instructions are on the following pages.

Please keep these instructions for future reference.

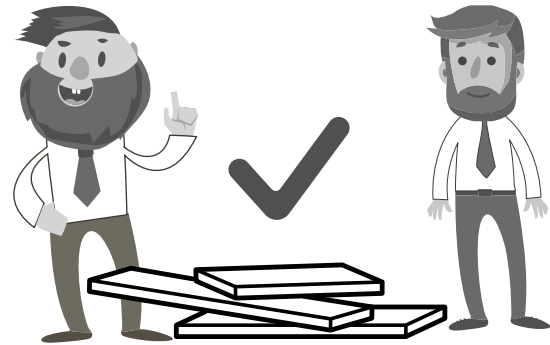
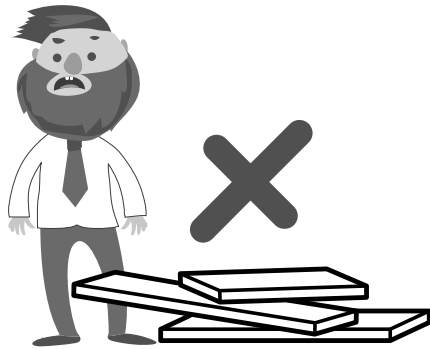
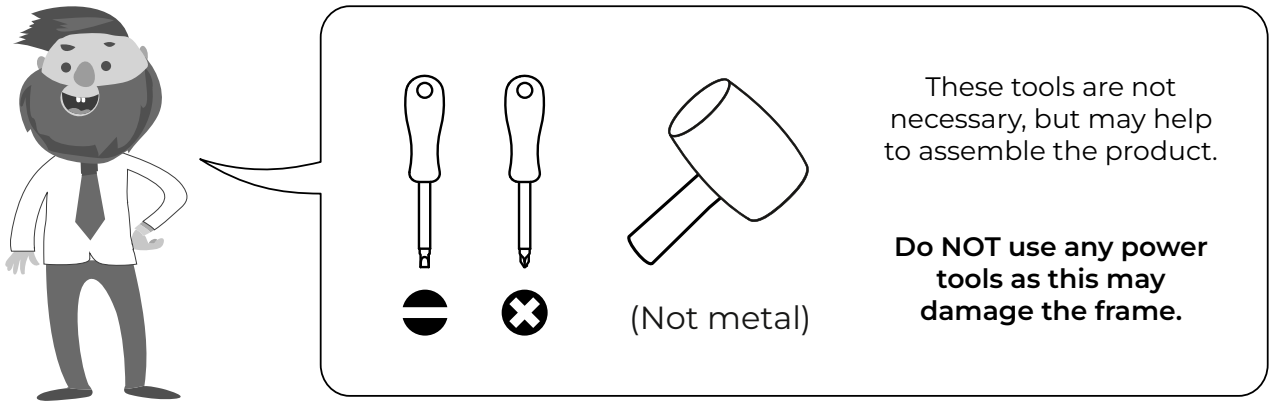

This product or some parts of this product will be heavy. Please use an assistant when lifting.

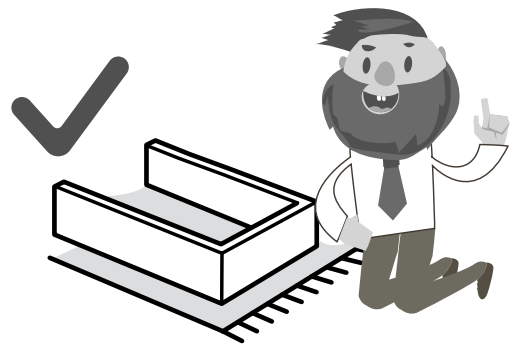
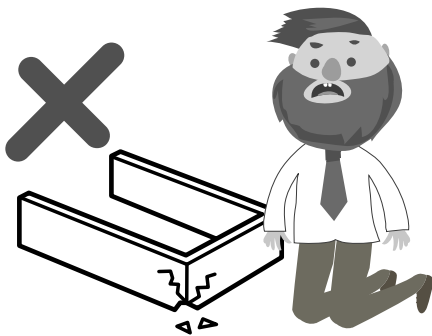

Never drag or push the pieces across a hard or stone floor as this will cause damage to the joints. Use a carpet or a rug for extra care.

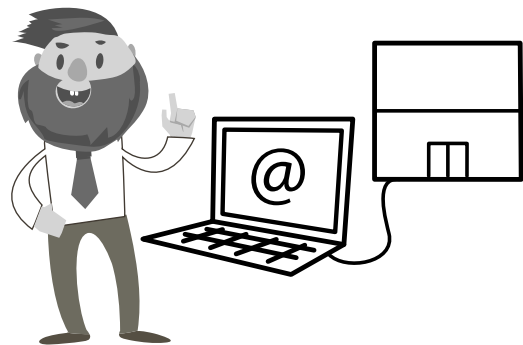
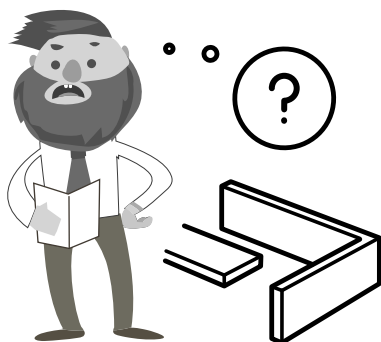

If you have problems assembling or have damaged or missing pieces, please contact our customer services (details at the back of these instructions)

The maximum weight allowed on each shelf: 2kg.

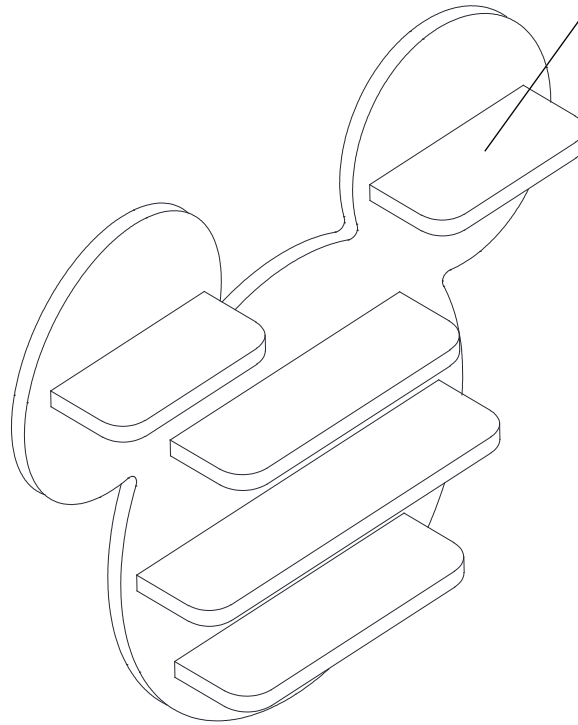

MICKEY MOUSE SHELF

Product Code:
DIS-MICSHU

BIRLEA FURNITURE LTD
UNIT 6A-1, WEST MEADOW RISE,
CASTLE
DONINGTON, DERBYSHIRE, DE74 2HL

CERTIFICATION LABEL

This storage unit models have been tested by an independent laboratory and is in compliance with FIRA/FRQG C001: 2021- Furniture - Children's Domestic Furniture - General safety requirements; FIRA/FRQG C004: 2016 + A1: 2017- Furniture - Children's Domestic Furniture - Storage Furniture - Requirements for Strength, Stability and Durability.



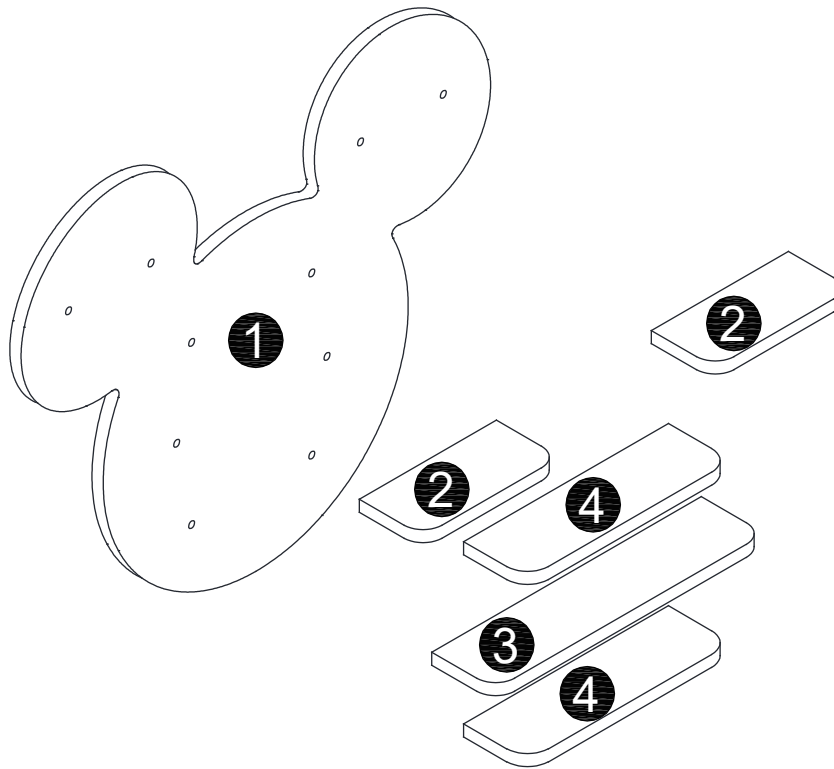

Factory ID: Manufactured in China
Date of Manufacture: 1222(MMY)

WARNING: THIS PRODUCT IS SUITABLE FOR CHILDREN IN THE AGE RANGE 5-12 YEARS.



Parts List			
PART	DESCIRPTION	QTY	BOX
1	Back Panel	1	1
2	Shelf	2	1
3	Shelf	1	1
4	Shelf	2	1

HARDWARE (IN BOX 1)

A		M6x40mm	10	C		Ø25mm	2
B		Ø10x10mm	10	D		M3x10mm	4

**You will need a Phillips head screwdriver and a Flat head screwdriver (not provided).

01

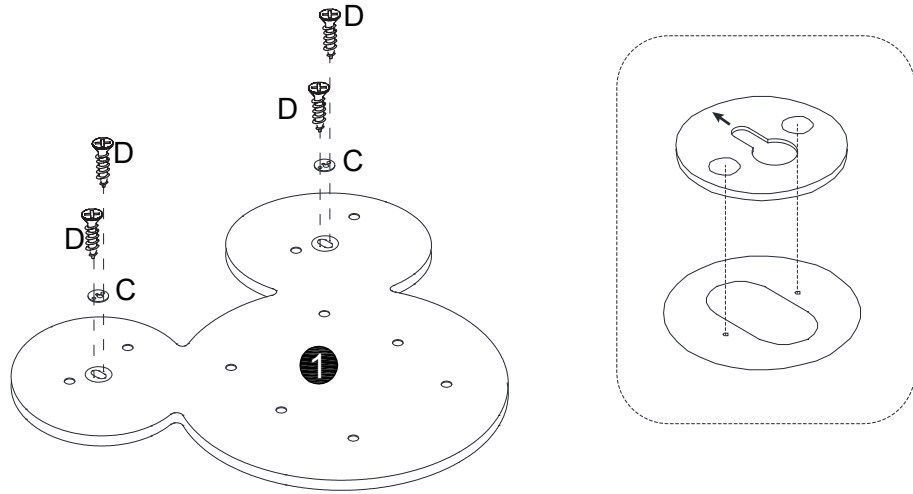

C	Ø25mm	2
D	M3x10mm	4

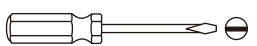
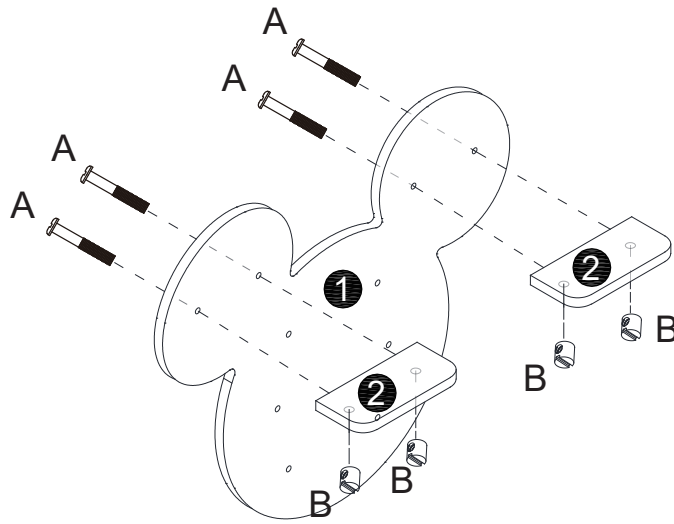

02



A	M6x40mm	4
B	Ø10x10mm	4

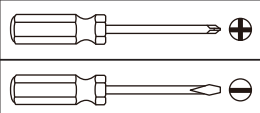
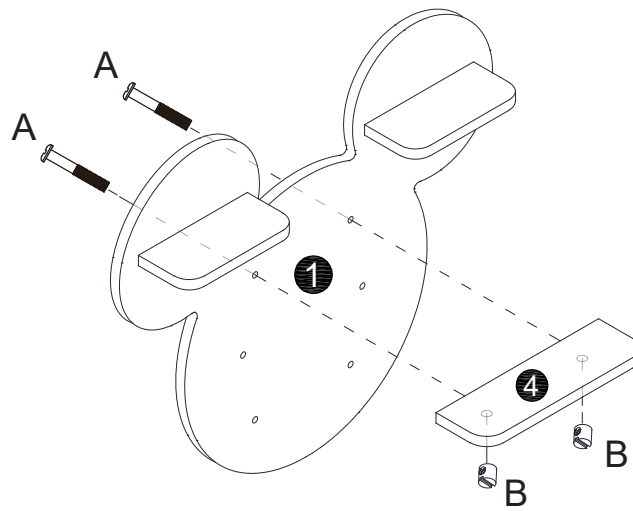

03

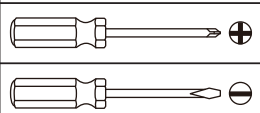
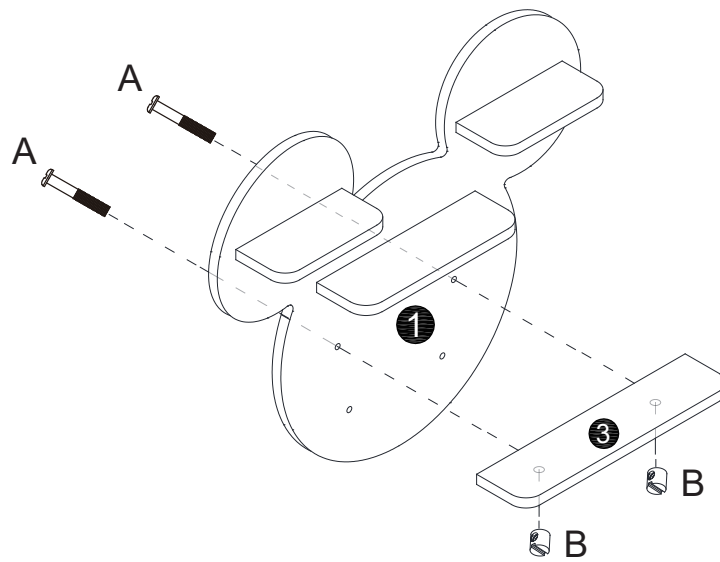

A	 M6x40mm	2
B	 Ø10x10mm	2

04



A	 M6x40mm	2
B	 Ø10x10mm	2

05

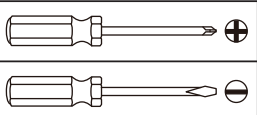
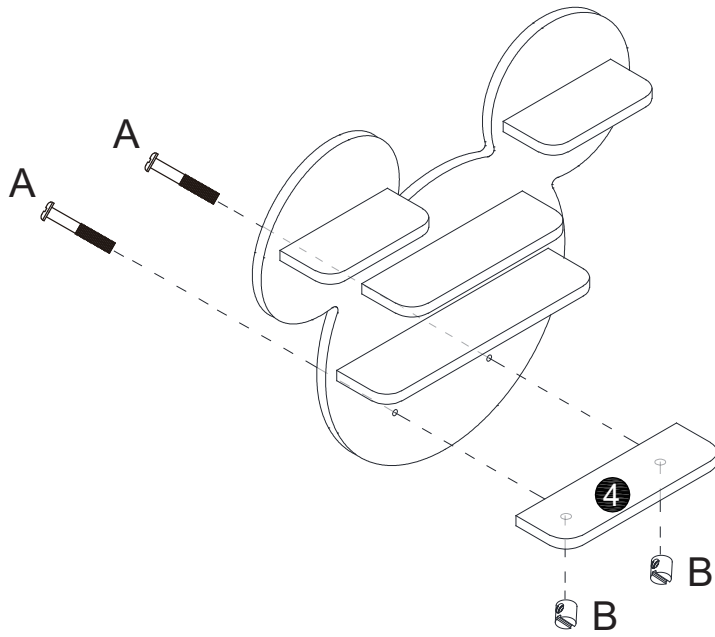

A	 M6x40mm	2
B	 Ø10x10mm	2

06

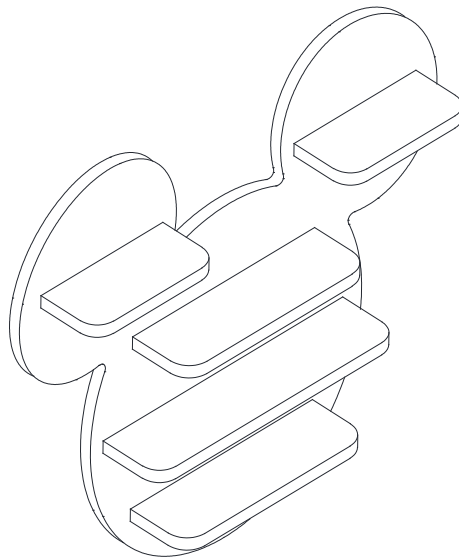

07

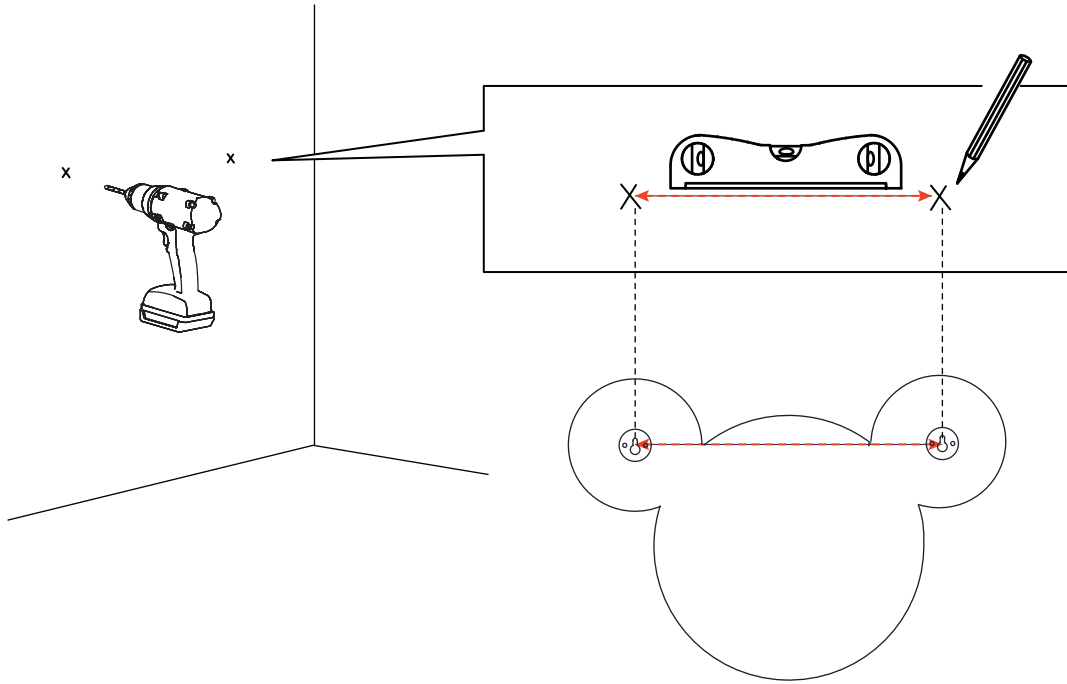

08

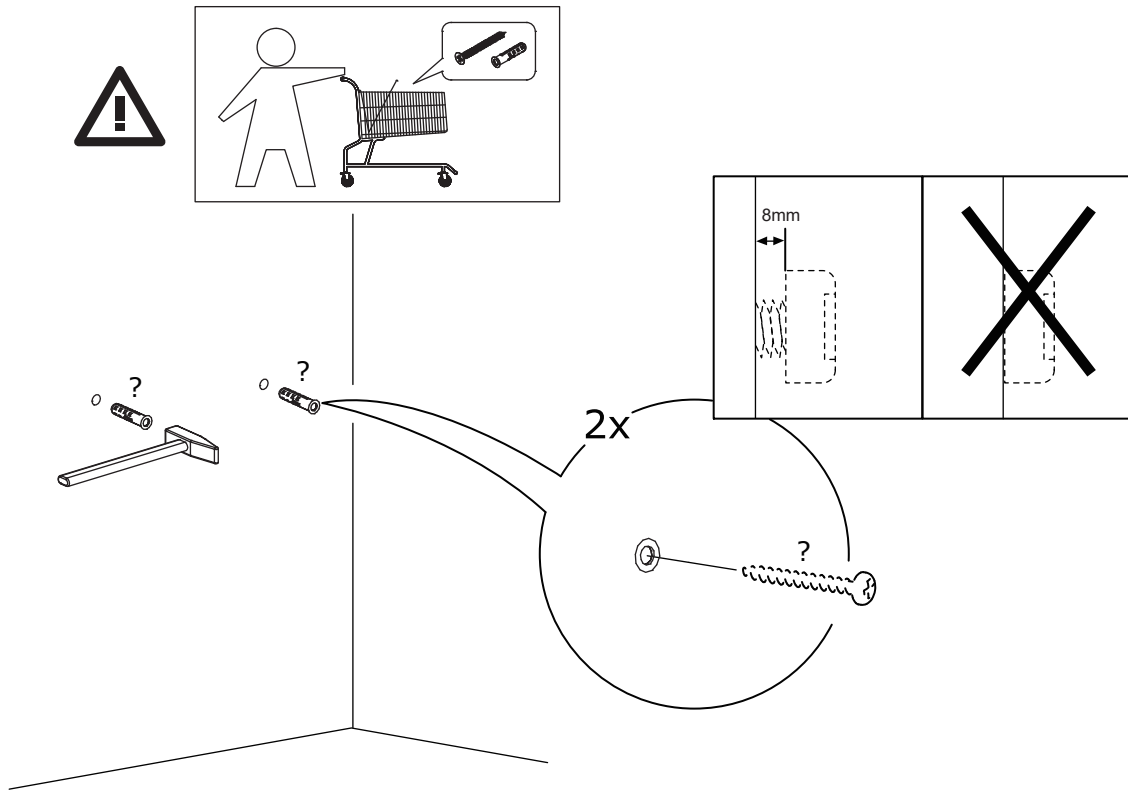

As wall materials vary, screws for fixing to wall are not included. Please contact your DIY or hardware store for advice on the correct type of screws/wall plugs for your type of wall.

09

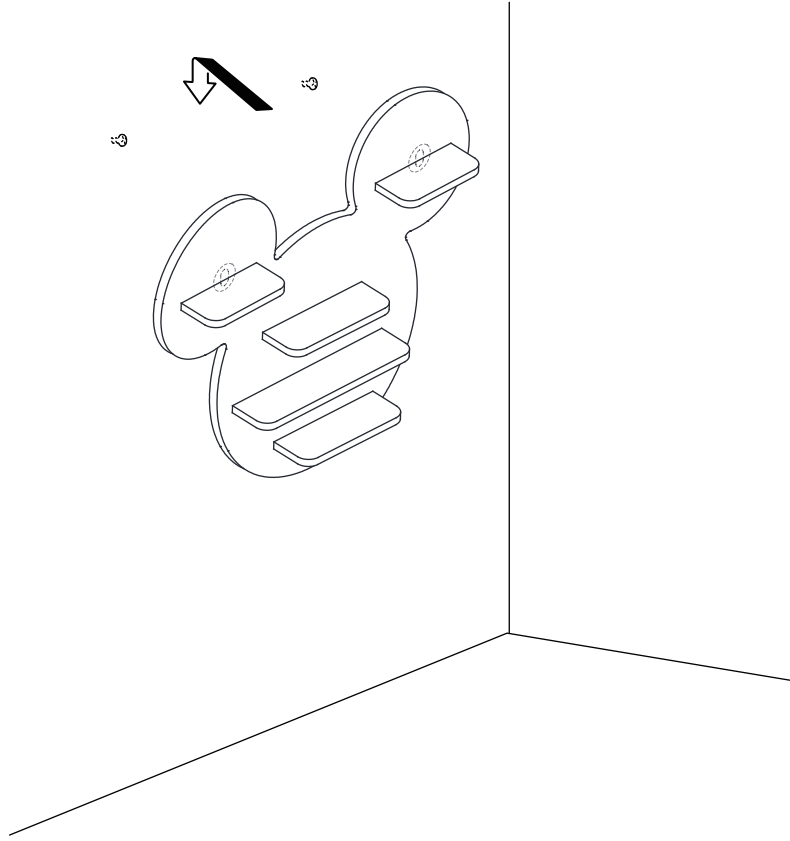

10

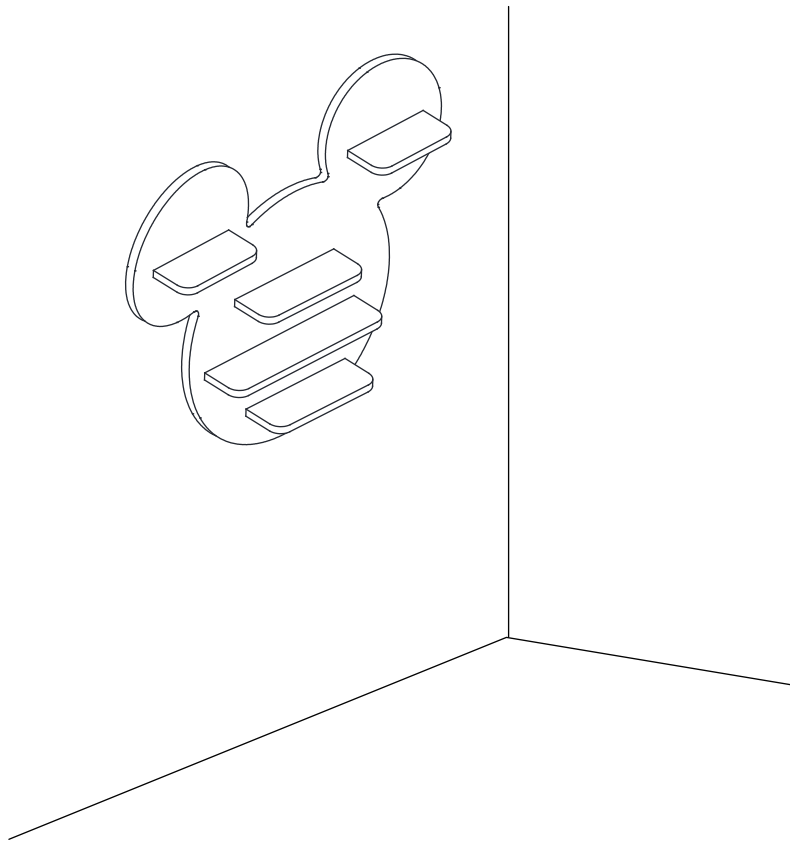

Please dispose of all packaging safely.

General Care & Maintenance

Wipe clean with a slightly damp cloth.
Avoid the use of all household cleaners and abrasives.

Periodically check all screw & fixings to ensure they are secure.

When moving your product, carefully lift into place. Never drag or push the product across the floor as this will cause damage to the joints. If the product is used on hard flooring, such as wood or laminated floor, you must place some protection under the legs to stop the product from moving. If this is not adhered to, it could result in failure to the product that will invalidate the warranty.

For more information on cleaning and product care visit:
<https://www.happybeds.co.uk/help-and-advice>

Notes

In the unlikely event that you have problems putting this product together or have damaged or missing parts, please contact us by visiting:
<https://www.happybeds.co.uk/customer-service>