

Assembly Instructions

Important before assembly:

Read these instructions carefully before assembling or using the product.

Please check the contents of the boxes before attempting to assemble this product. The instructions will have a checklist of parts and fittings.

Assemble the product as close to its intended final location/room as possible.

Health & Safety:

This product or some parts of this product will be heavy. Please use an assistant when lifting.

Please keep small parts out of reach of children.

Always use on a level, even surface.

DO NOT jump on the product or any of its parts.

DO NOT use this product if any parts are missing, damaged or worn.

DO NOT use this product unless all fixings are secured.

Further instructions are on the following pages.

Please keep these instructions for future reference.



This product or some parts of this product will be heavy. Please use an assistant when lifting.



Never drag or push the pieces across a hard or stone floor as this will cause damage to the joints. Use a carpet or a rug for extra care.



If you have problems assembling or have damaged or missing pieces, please contact our customer services (details at the back of these instructions)



Box 1

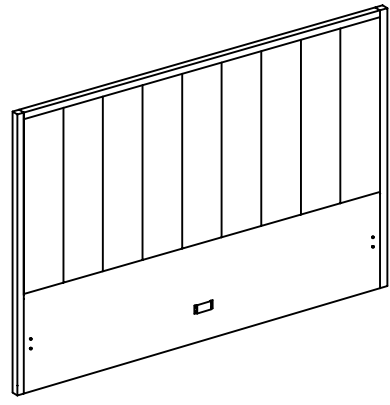

1.Headboard (x1)

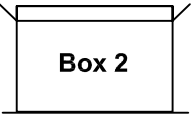

Box 2

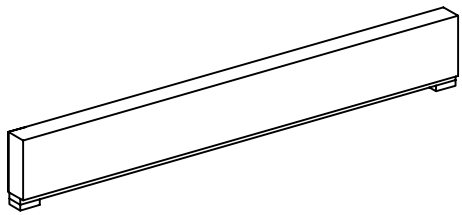

2.Footboard (x1)

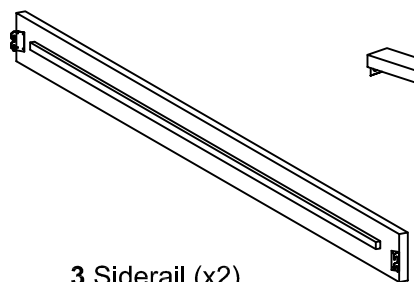

3.Siderail (x2)

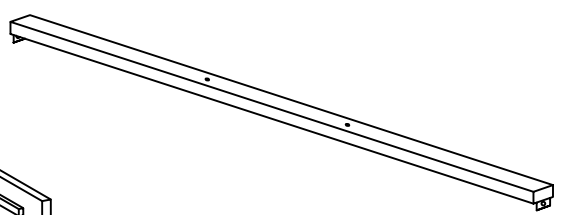

4.Centre Rail (x1)

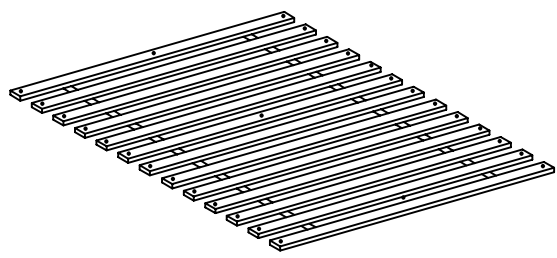

5.Slats (x1)



6.Support Legs (x2)

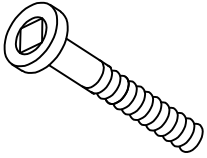

A. M6 x 40 mm JCBC (x2)

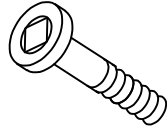

B. M6 x 30 mm JCBC (x8)



C. Allen Key M4 x 65 mm (x1)

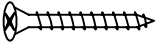

D. M4 x 25 mm CSK (x2)

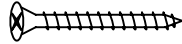

E. M4 x 32 mm CSK (x29)

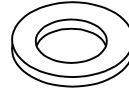

F. Flat Washer (x8)

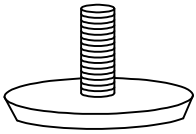

G. Adjustable Foot (x2)

***You will need a screwdriver (not provided)**

Step 1

Unpack all components from the boxes and check you are not missing anything. Please check these against the list on page 3 & 4. Should you identify any missing components, please contact the retailer you purchased the bed from.

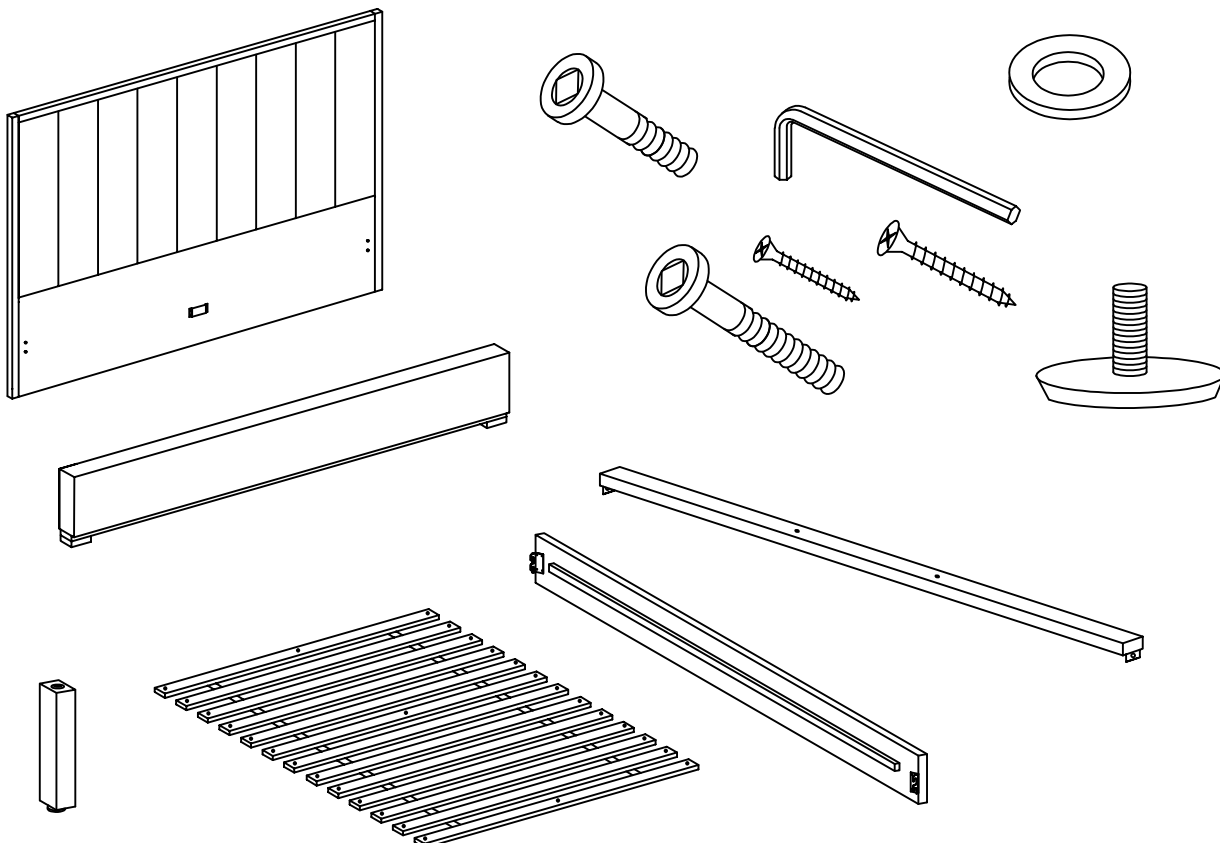

Step 2

Attach Side Rail (3) x2 to Footboard (2) and Headboard (1) using JCBC M6 x 30 (B) and Flat Washer (F).

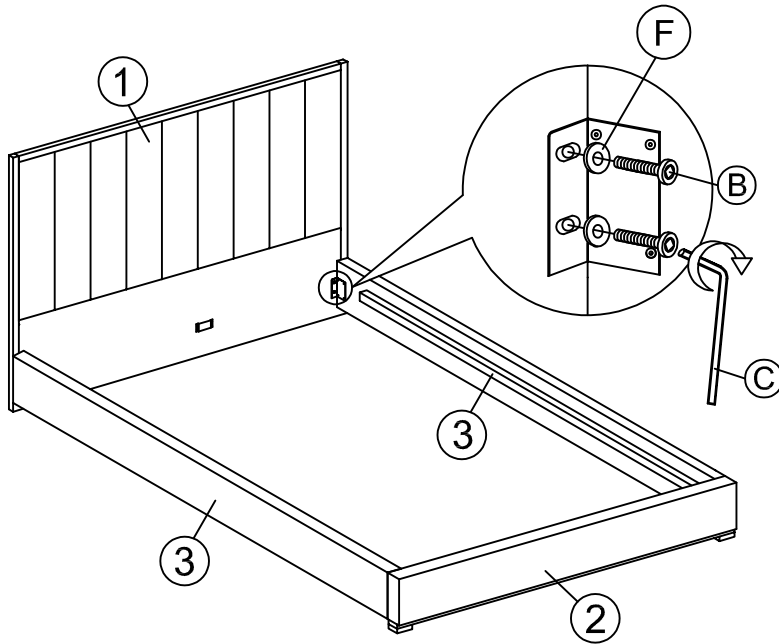

Step 3

Attach the 2x support legs (6) to 1x centre rail (4) using 2x M6x40mm JCBC (A) and 1x M4 Allen Key (C). Then screw 2x Adjustable Foot (G) to 2x support legs (6).

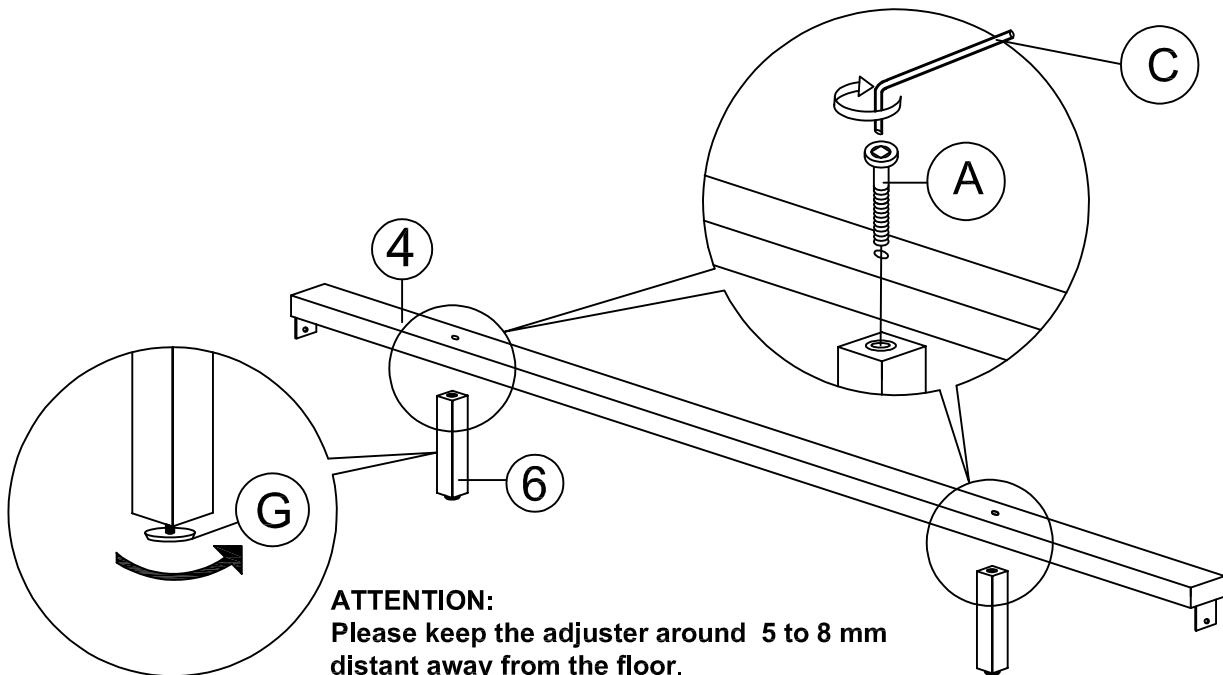

DO NOT use any power tools as this may damage the frame and will invalidate any claim.

Step 4

Firstly, slot the 1x centre rail (4) to the bracket on 1x Headboard (1) and 1x Footboard (2). Then secure using 2x M4x25mm CSK (D) and Screwdriver (Not Provided).

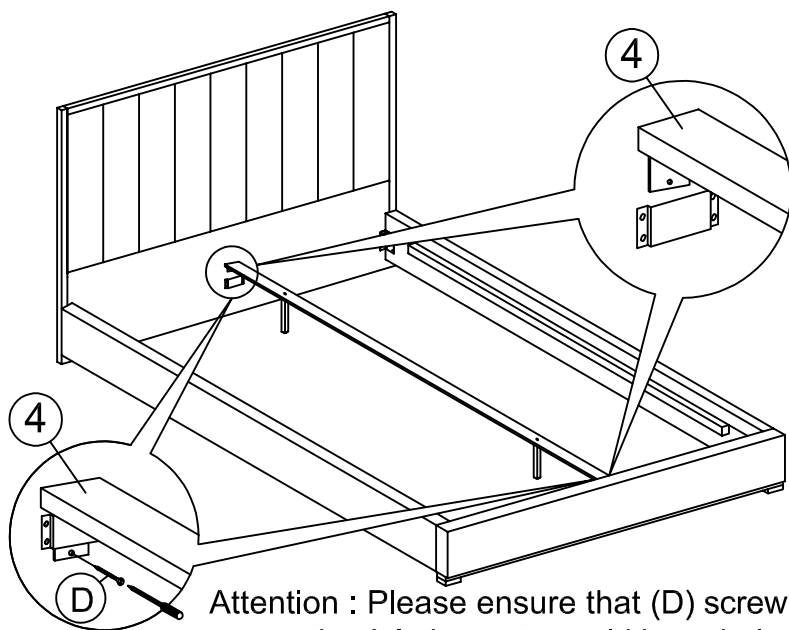

Attention : Please ensure that (D) screw is being attach as per the A.I shown to avoid base being collapse.

Step 5

Lay the slats (5) onto the support wood on 2 x side rail (3) and the 1 x center rail (4). Place slats so the ribbon is underneath. Insert CSK screw (E) into pre-drilled holes in slats and tighten with screwdriver.

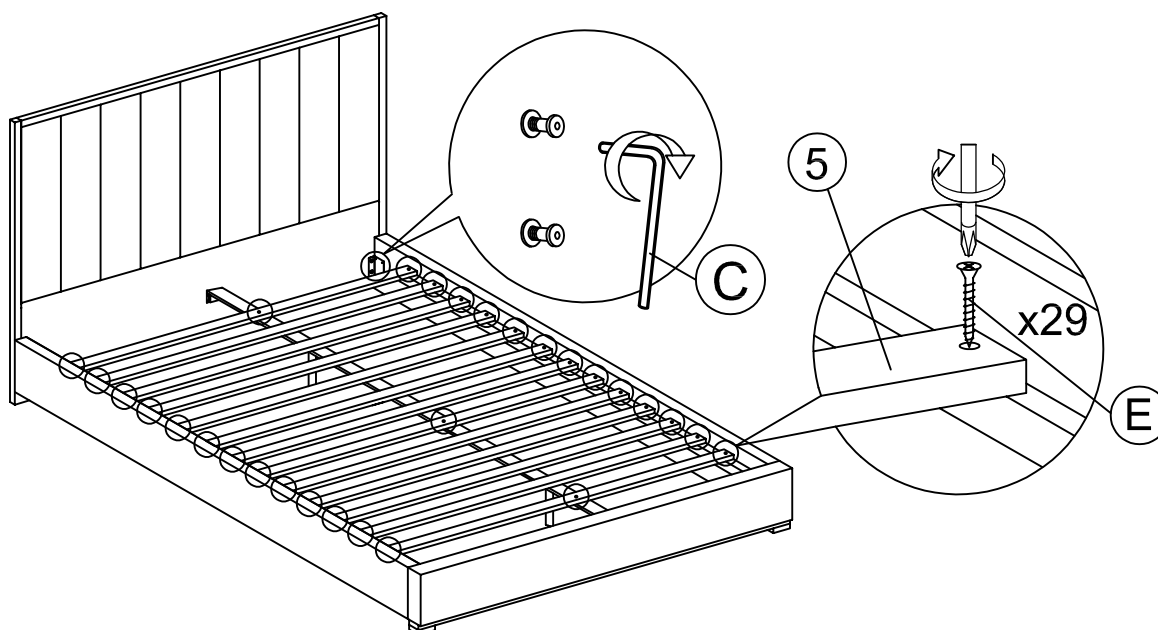

DO NOT use any power tools as this may damage the frame and will invalidate any claim.

Please dispose of all packaging safely.

General Care & Maintenance

Wipe clean with a slightly damp cloth.
Avoid the use of all household cleaners and abrasives.

Periodically check all screw & fixings to ensure they are secure.

When moving your product, carefully lift into place. Never drag or push the product across the floor as this will cause damage to the joints. If the product is used on hard flooring, such as wood or laminated floor, you must place some protection under the legs to stop the product from moving. If this is not adhered to, it could result in failure to the product that will invalidate the warranty.

For more information on cleaning and product care visit:
<https://www.happybeds.co.uk/help-and-advice>

Notes

In the unlikely event that you have problems putting this product together or have damaged or missing parts, please contact us by visiting:
<https://www.happybeds.co.uk/customer-service>