

Assembly Instructions

Important before assembly:

Read these instructions carefully before assembling or using the product.

Please check the contents of the boxes before attempting to assemble this product. The instructions will have a checklist of parts and fittings.

Assemble the product as close to its intended final location/room as possible.

Health & Safety:

This product or some parts of this product will be heavy. Please use an assistant when lifting.

Please keep small parts out of reach of children.

Always use on a level, even surface.

DO NOT jump on the product or any of its parts.

DO NOT use this product if any parts are missing, damaged or worn.

DO NOT use this product unless all fixings are secured.

Further instructions are on the following pages.

Please keep these instructions for future reference.



This product or some parts of this product will be heavy. Please use an assistant when lifting.



Never drag or push the pieces across a hard or stone floor as this will cause damage to the joints. Use a carpet or a rug for extra care.



If you have problems assembling or have damaged or missing pieces, please contact our customer services (details at the back of these instructions)

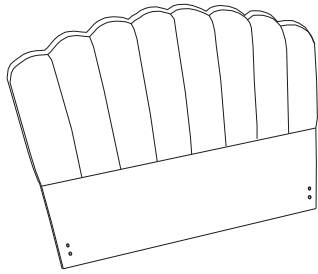
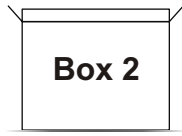

3. Headboard (x1)

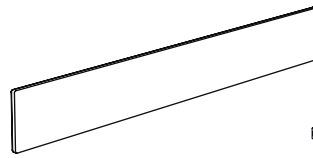

4. Side Rails (x2)

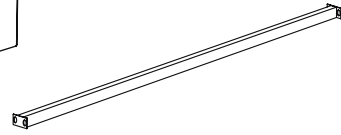

6. Centre Support Rail (x1)

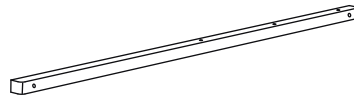

16. Left Right Frame Rail (x1)

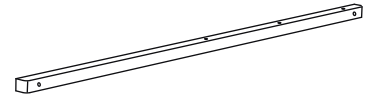

17. Right Frame Rail (x1)

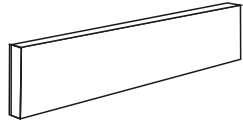
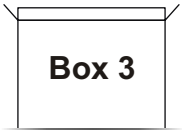

2. Footboard (x1)

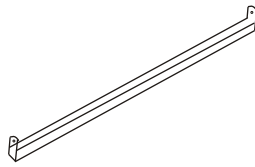

5. Bed Cross Bar(x1)

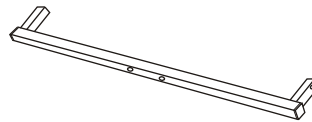

15. Back Frame Rail(x1)

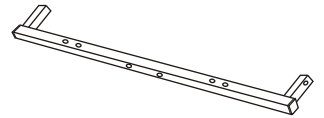

14. Front Frame Rail(x1)

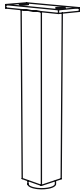

10. Support Leg (x1)

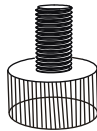

8. Legs (x4)



M. Slat Caps (x28)

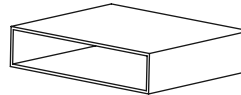

N. Centre Slat Caps (x14)



11. metal hook (X2)



1. Baton (x1)

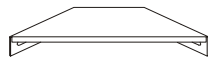

7. corner bracket (X4)



12. Pull Strap (x1)

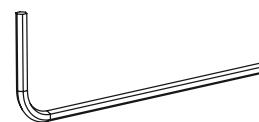

A. M5 Allen Key (x1)

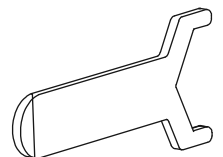

F. Spanner (x1)



I. M4 Allen Key (x1)

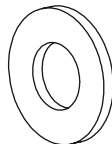

D. Flat Washer (X8)



C. Spring Washer (x8)

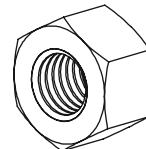

E. Nuts (x12)

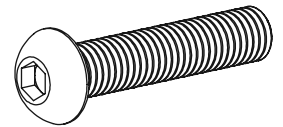

L. M8x45mm Bolts (x4)

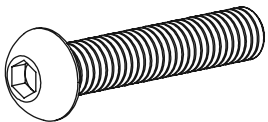

H. M8x40mm Bolts (x6)

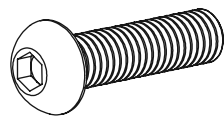

B. M8x30mm Bolts (x8)

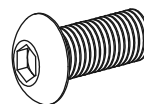

J. M8x16mm Bolts (x4)

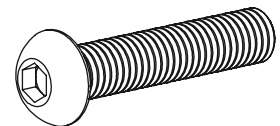

K. M8x65mm Bolts (x4)

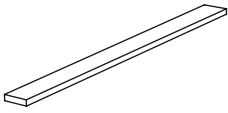

9.Slats(x28)

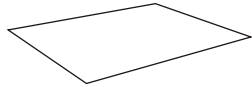

13.Woven Fabric (X1)

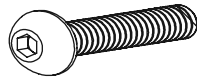

G. M6x16mm Bolts (x10)

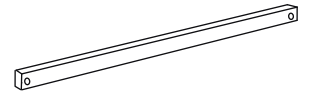

18.Cross Support Bar(x2)

Step 1

Unpack all components from the boxes and check you are not missing anything. Please check these against the list on page 3 & 4. Should you identify any missing components, please contact the retailer you purchased the bed from.

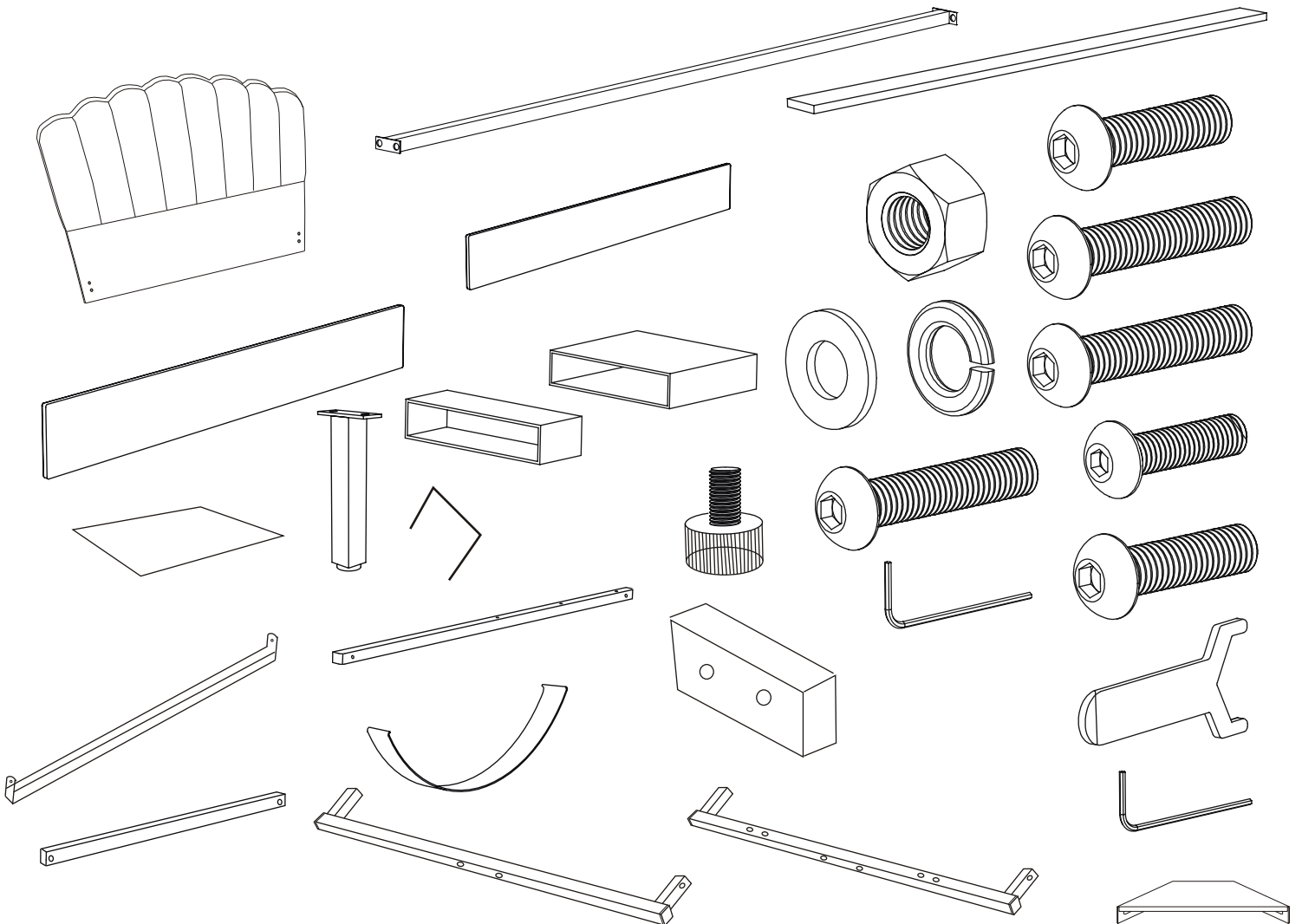

Step 2

Attach 2x Legs (8) to the 1x Headboard (3) and then attach 2x Legs (8) to the 1x Footboard (2) using the Allen Key (A), 4x M8x30mm Bolts (B), 4x Spring Washer (C) and 4x Flat Washer (D). **DO NOT FULLY TIGHTEN BOLTS DO NOT USE ANY POWER TOOLS AS THIS MAY DAMAGE THE BED FRAME AND WILL INVALIDATE ANY CLAIMS.**

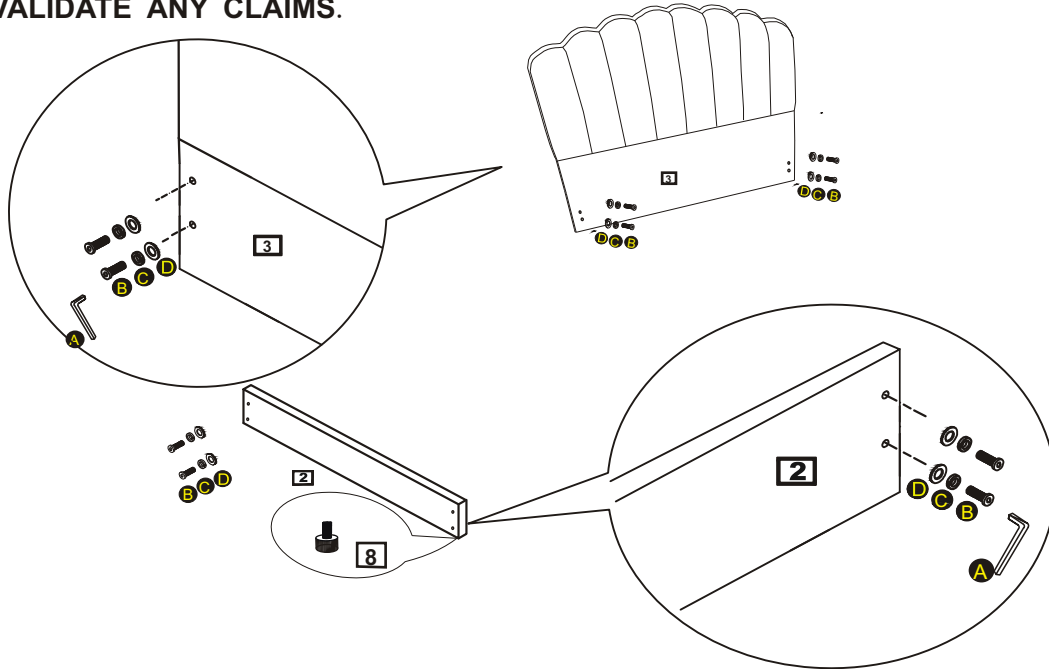

- 3** Headboard x1
- 2** Footboard x1
- 8** Legs x 4
- B** Bolts (M8x30mm) x8
- C** Spring washer x8
- D** Flat washer x8
- A** M5 Allen Key

Step 3

To fix the side rails (4) to the headboard (3) and footboard (2) you will need to use hardware parts B, C, D with the M5 allen key (A).

To fix the wooden block (1) to the footboard (2) you will need to use hardware parts L with the M5 allen key (A).

To attach the corner bracket with pad (7) to the headboard (3), footboard (2) and side rails (4) you will need to use hardware parts G and the M4 allen key.

To fix the cross bar (5) to the side rails (4) you will need to use hardware G With M4 allen key (I).

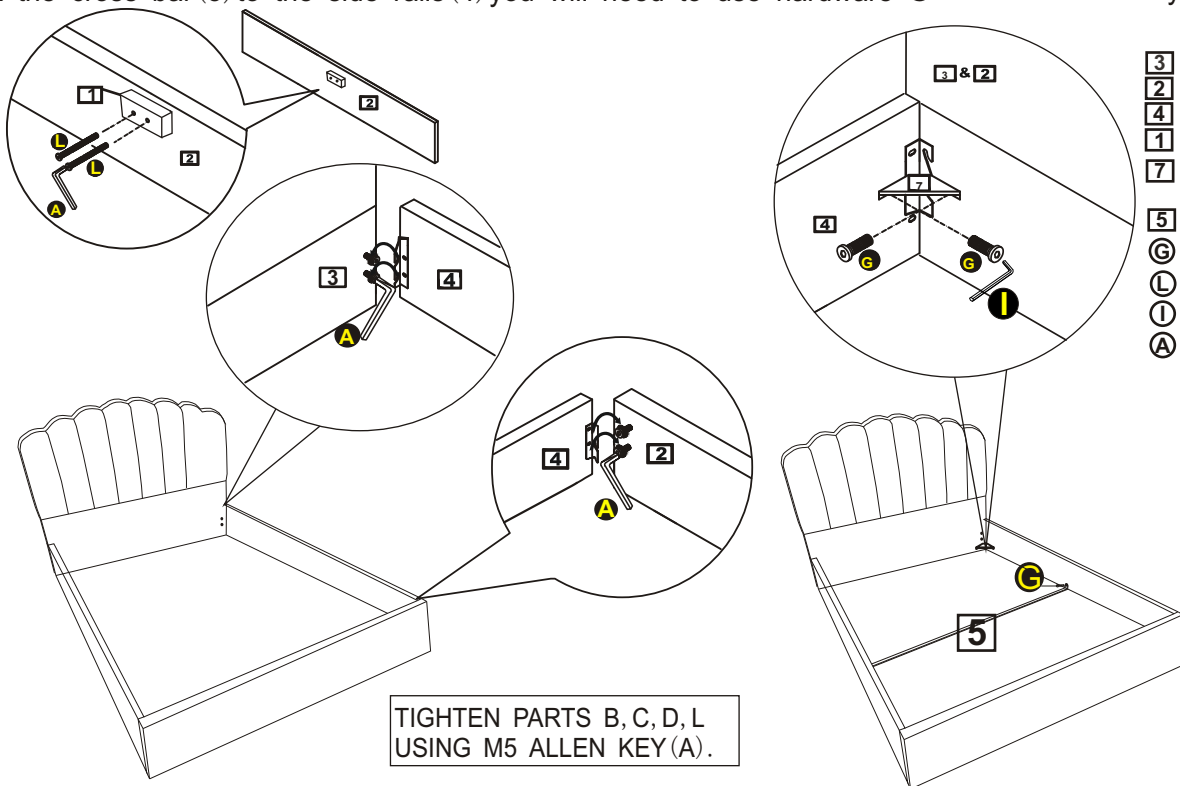

- 3** Headboard x1
- 2** Footboard x1
- 4** Side rail x 2
- 1** Wooden Block x 1
- 7** Corner Bracket with Pad x 4
- 5** Cross Bar
- G** Bolts (M6x16mm) x10
- L** Bolts (M8x45mm) x 2
- I** M4 Allen Key
- A** M5 Allen Key

TIGHTEN PARTS B, C, D, L USING M5 ALLEN KEY (A).

MAKE CERTAIN THE BED IS SQUARE AS SHOWN.

Note: THEN tighten all bolts 100% using allen key

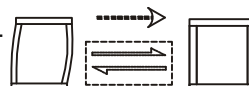

Step 4

To attach the front frame rail (14) and back frame rail (15) to the left frame rail (16) and right frame rail (17), you will need hardware parts J with the M5 allen key (A).

To attach the centre support bar (6) to the front frame rail (14) and back frame rail (15), you will need hardware parts H and E with the M5 allen key (A) and the M14 spanner (F).

To attach the support leg (10) to the centre support bar (6), you will need hardware parts H and E with the M5 allen key (A) and the M14 spanner (F).

Insert the metal hook (11) to the front frame rail (14).

DO NOT use any power tools as this may damage the bed frame and will invalidate any claims.

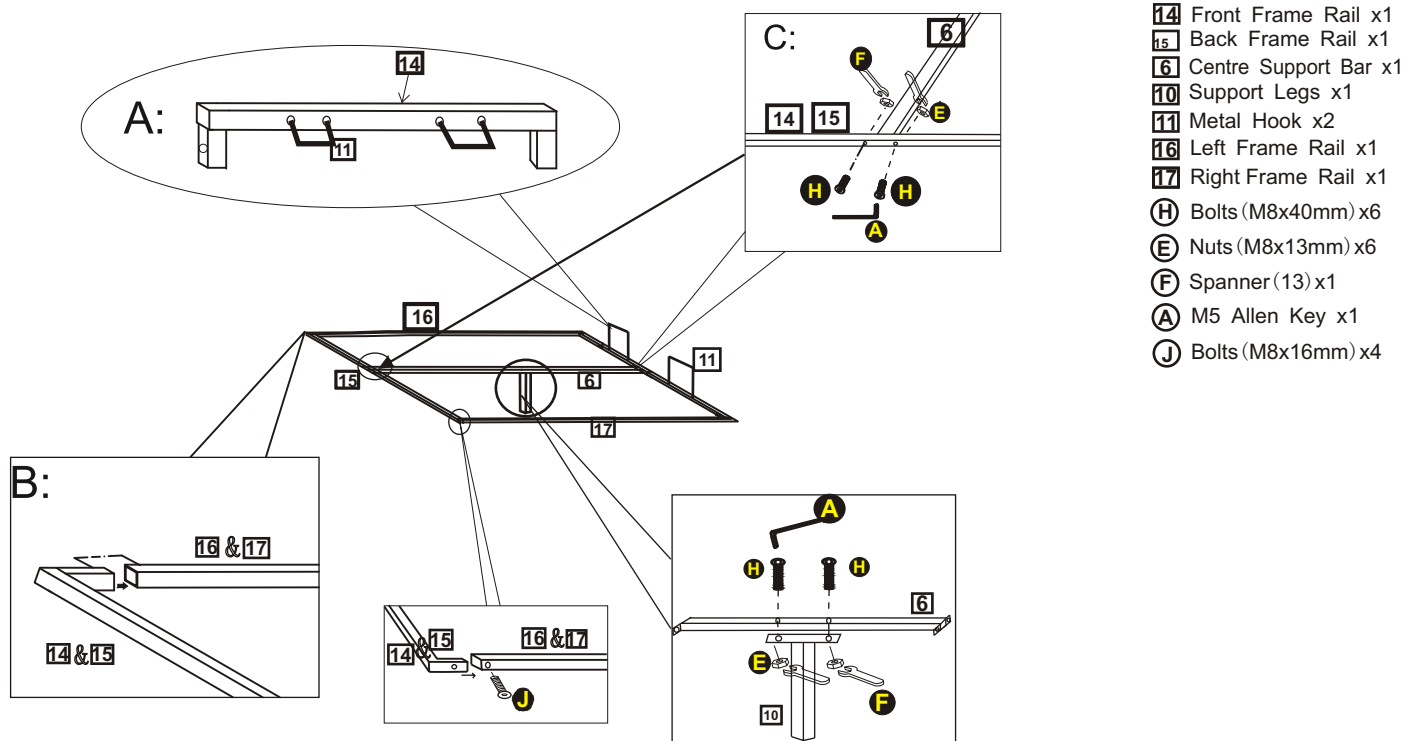

- 14 Front Frame Rail x1
- 15 Back Frame Rail x1
- 6 Centre Support Bar x1
- 10 Support Legs x1
- 11 Metal Hook x2
- 16 Left Frame Rail x1
- 17 Right Frame Rail x1
- H Bolts (M8x40mm) x6
- E Nuts (M8x13mm) x6
- F Spanner (13)
- A M5 Allen Key x1
- J Bolts (M8x16mm) x4

Step 5

To attach the metal frame (14/15/16/17) and cross support bar (18) to the gas lift pre-fixed to the side rails, you will need to use hardware parts K, E and L with the M5 allen key (A) and the M14 spanner (F).

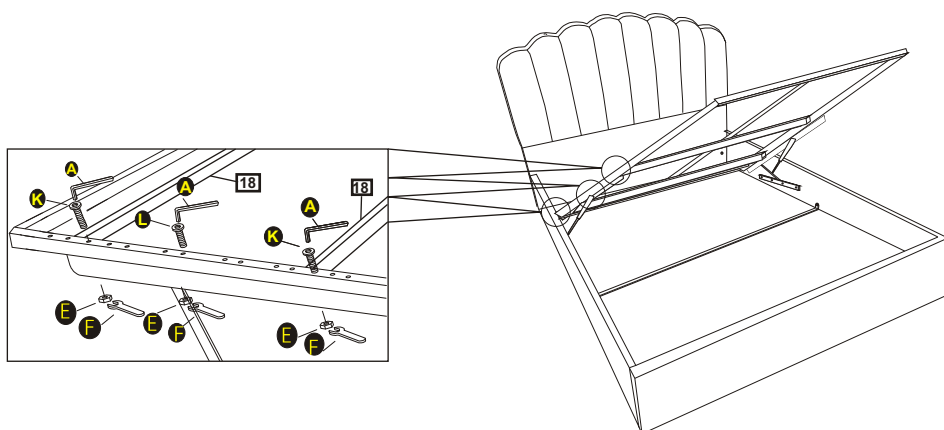

- 18 Cross Support Bar x2
- K Bolts (M8x65mm) x4
- E Nuts (M8x13mm) x6
- F Spanner (13)
- A M5 Allen Key
- L Bolts (M8x45mm) x2

Step 6

To attach the pull strap (12) to the back frame rail (15) you will place the pull strap (12) beneath the metal frame and then pull the strap on the inner side of the frame through the strap on the outer side of the frame to form a knot.

To assemble the slats(9) place a single plastic cap(M) onto each end of every slat then you need to push centre slat caps(N) into the metal frame.

DO NOT use any power tools as this may damage the bed frame and will invalidate any claims.

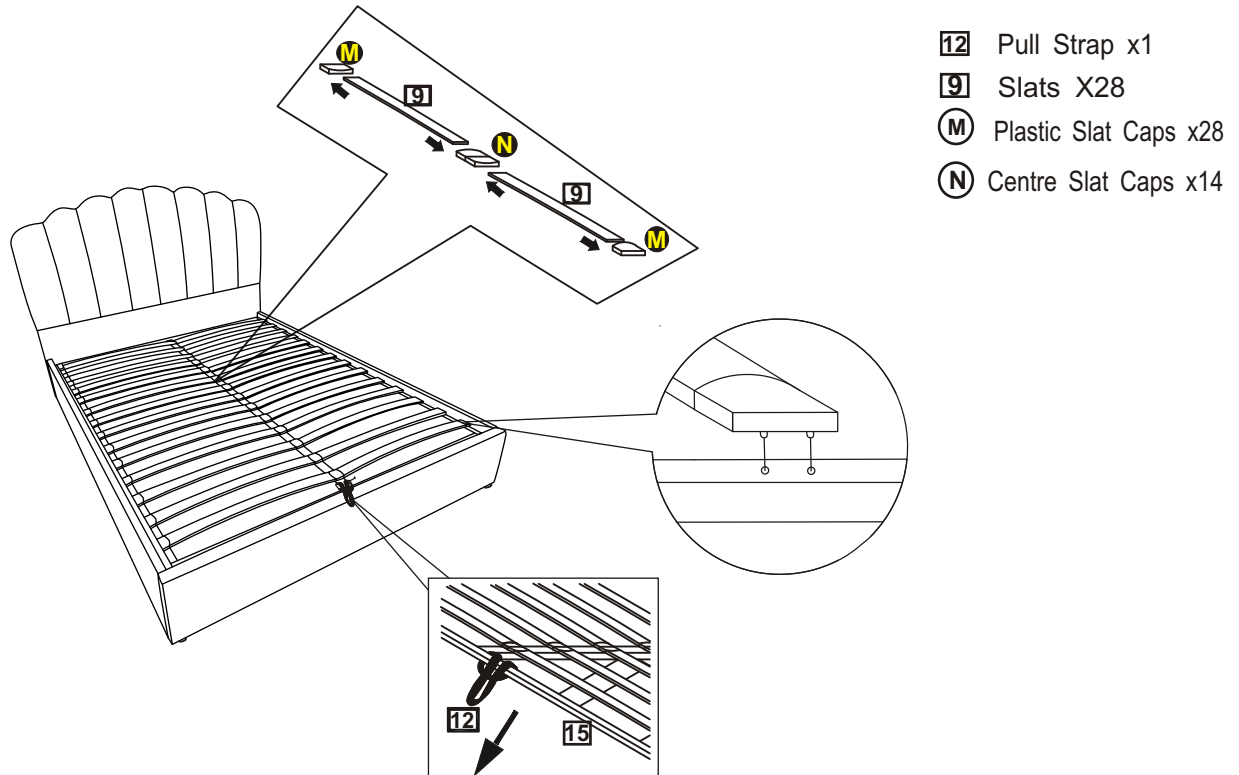

Step 7

Tilt the bedframe on to its side and attach the woven fabric (13).

CAUTION: WHEN BED TILTED BE CAREFUL OF THE OTTOMAN FRAME SPRINGING OUT.

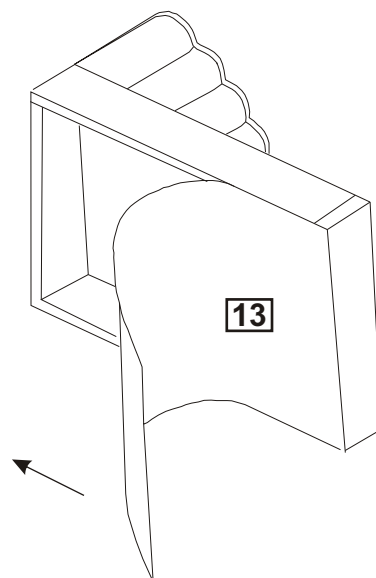

Woven Fabric x1

Please dispose of all packaging safely.

General Care & Maintenance

Wipe clean with a slightly damp cloth.
Avoid the use of all household cleaners and abrasives.

Periodically check all screw & fixings to ensure they are secure.

When moving your product, carefully lift into place. Never drag or push the product across the floor as this will cause damage to the joints. If the product is used on hard flooring, such as wood or laminated floor, you must place some protection under the legs to stop the product from moving. If this is not adhered to, it could result in failure to the product that will invalidate the warranty.

For more information on cleaning and product care visit:
<https://www.happybeds.co.uk/help-and-advice>

Notes

In the unlikely event that you have problems putting this product together or have damaged or missing parts, please contact us by visiting:
<https://www.happybeds.co.uk/customer-service>