

## Assembly Instructions

### Important before assembly:

Read these instructions carefully before assembling or using the product.

Please check the contents of the boxes before attempting to assemble this product. The instructions will have a checklist of parts and fittings.

Assemble the product as close to its intended final location/room as possible.

### Health & Safety:

This product or some parts of this product will be heavy. Please use an assistant when lifting.

Please keep small parts out of reach of children.

Always use on a level, even surface.

DO NOT jump on the product or any of its parts.

DO NOT use this product if any parts are missing, damaged or worn.

DO NOT use this product unless all fixings are secured.

**Further instructions are on the following pages.**

Please keep these instructions for future reference.

# Happy beds™

www.happybeds.co.uk

No	Part List	Qty	Box
1	Headboard	1 pc	1
2	Footboard	1 pc	3
3	Side rail - LH	1 pc	2
4	Side rail - RH	1 pc	2
5	"U" shaped cross bar	1 pc	3
6	Angled corner brackets	2 pcs	3
7a	Gas-lift mechanism	1 pc	3
7b	Gas-lift mechanism	1 pc	3



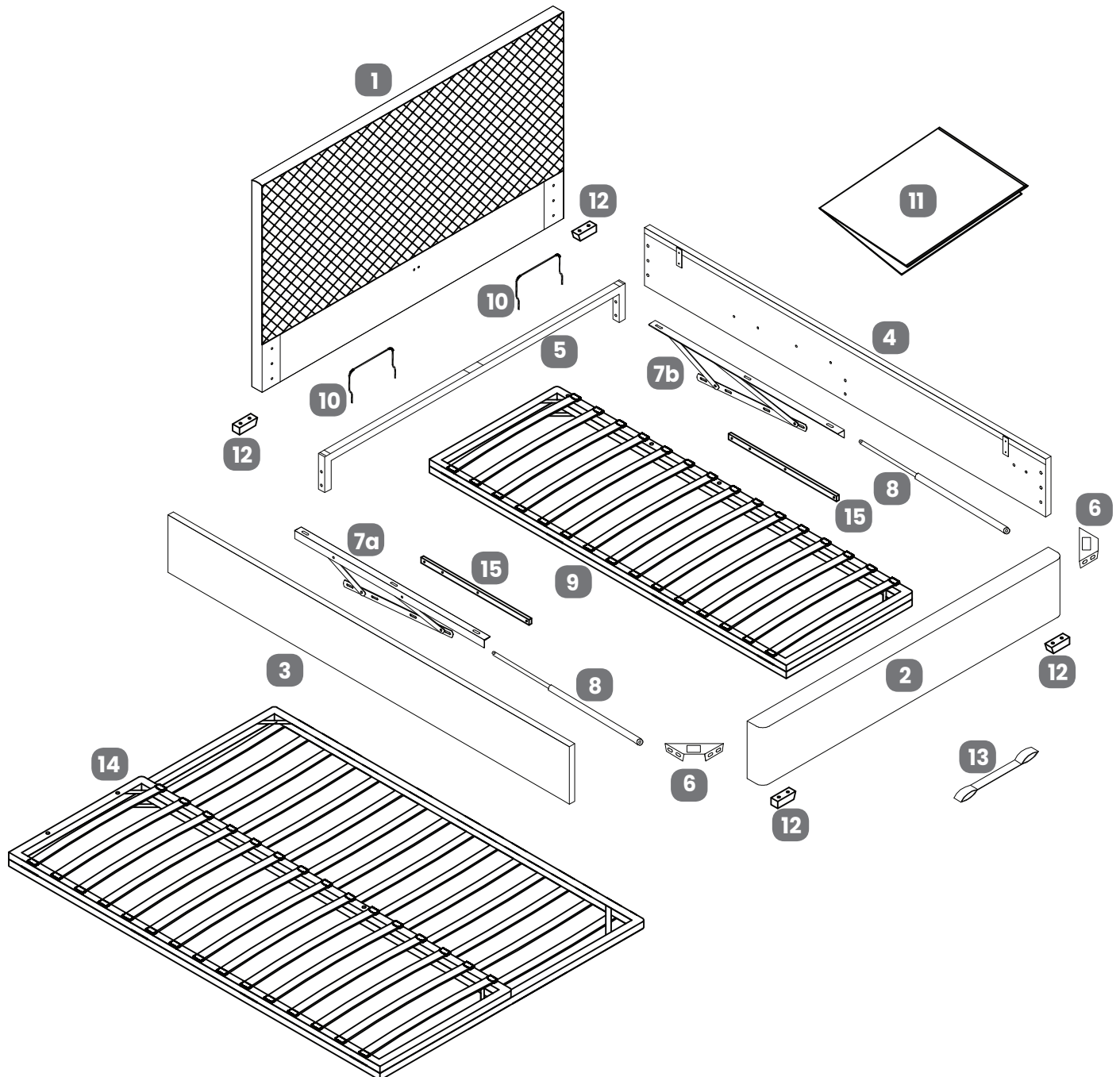





No	Part List	Qty	Box
8	Gas-lift pistons	2 pcs	3
9	Metal slat frame - double or king size	1 pc	3
10	Mattress stoppers	2 pcs	3
11	Fabric base cover	1 pc	3
12	Feet	4 pcs	3
13	Fabric hand strap	1 pc	3
14	Metal slat frame - only for super king size	1 pc	3
15	Spacer rails for mechanism	2 pcs	3





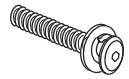

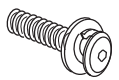
# Happy beds™

www.happybeds.co.uk

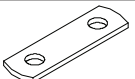
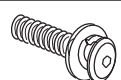

## HARDWARE NEEDED FOR BED ASSEMBLY (PACK A)

No	Hardware List	Qty	Box	No	Hardware List	Qty	Box
A	Bolt (M8x20mm) for fitting hook bracket (G&H) to side rail 	12 pcs	3	F	'L' shape bracket 	Double & King 2 pcs	3
B	Bolt (M6x20mm) for fitting bracket (L) to headboard and footboard  Double & King 12 pcs Super King 16 pcs	3	G			Hook bracket 	
C	Bolt (M6x45mm) for fitting 'U' shape cross bar to side rails 	12 pcs	3	H	Hook bracket 	2 pcs	3
D	Allen key for M6 bolts 	1 pc	3	I	Bolt (M8x35mm) for fitting hook bracket (G&H) to headboard and footboard 	12 pcs	3
E	Allen key for M8 bolts 	1 pc	3				

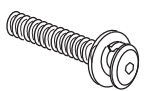
## HARDWARE NEEDED FOR SLAT FRAME ASSEMBLY & FITTING (PACK B)



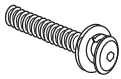

No	Hardware List	Qty	Box	No	Hardware List	Qty	Box
A	Bolt (M8x20mm) for fitting metal connection plate (M) to metal slat frame 	4 pcs	3	M	Metal connection plate 	2 pcs	3
I	Bolt (M8x35mm) for fitting lift mechanism (7a&7b) 	8 pcs	3	N	Flanged M8 lock-nuts 	10 pcs	3
K	Spring washer for M8 bolts 	6 pcs	3	O	Spanner for flanged M8 lock-nuts 	1 pc	3
J	Flat washer for M8 bolts 	6 pcs	3	P	Bolts (M8x50mm) for fitting metal slat frame (9 or 14) to gas-lift mechanisms (7) 	6 pcs	3

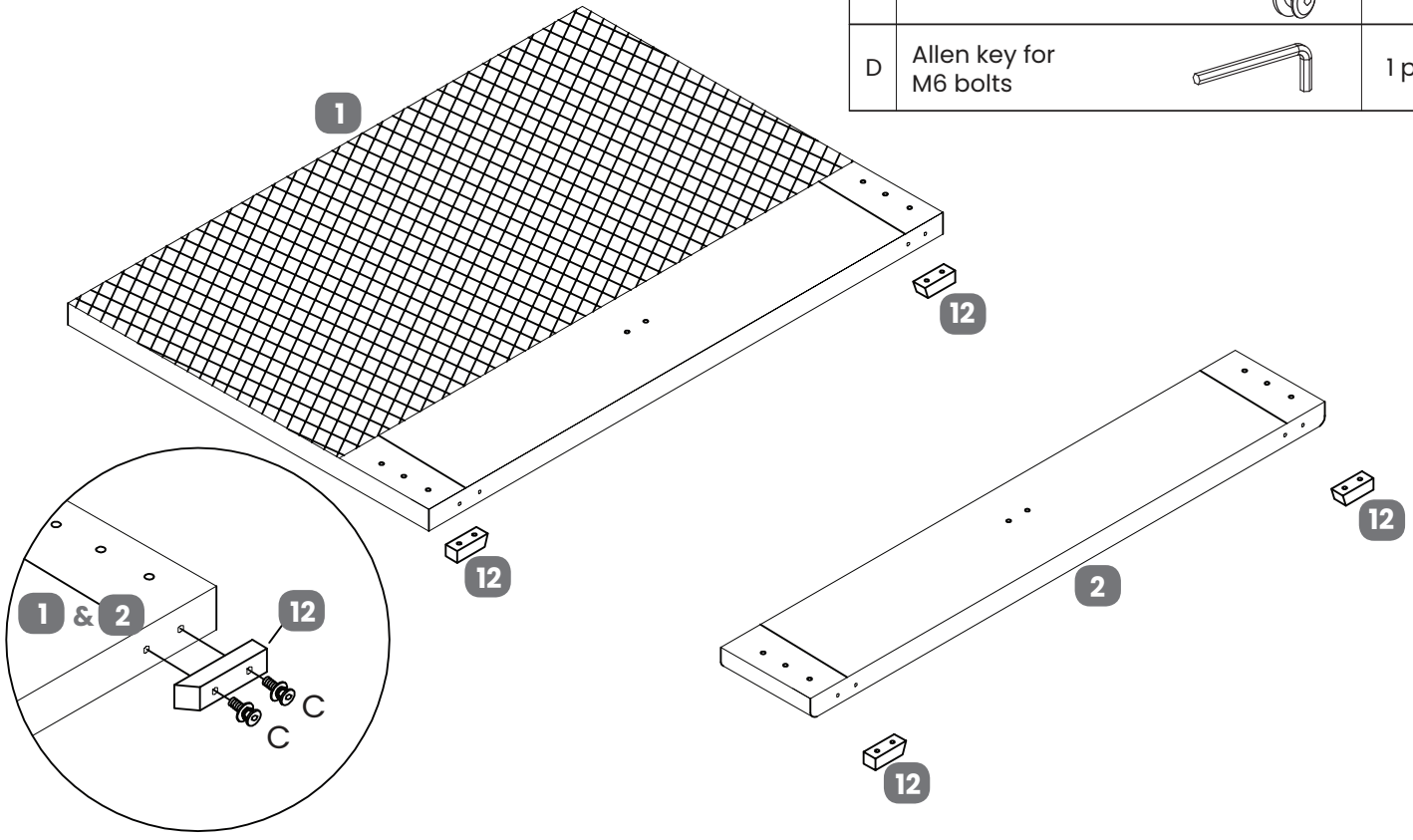
**Step 1:**

C	Bolts (M6x45mm)		8 pcs
D	Allen key for M6 bolts		1 pc



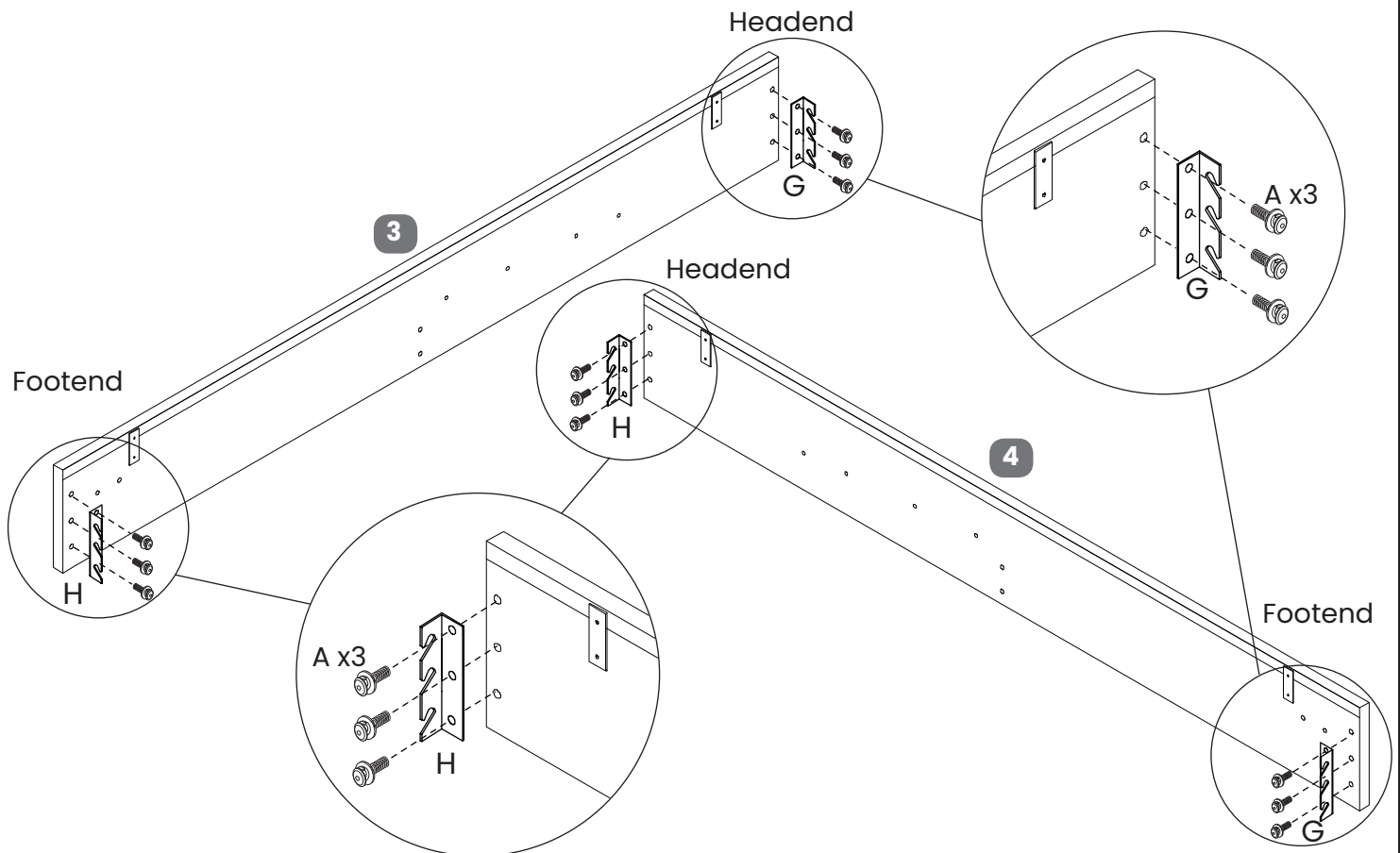

**Step 2:**

A	Bolts (M8x20mm)		12 pcs	G	Hook bracket		2 pcs
E	Allen key for M8 bolts		1 pc	H	Hook bracket		2 pcs



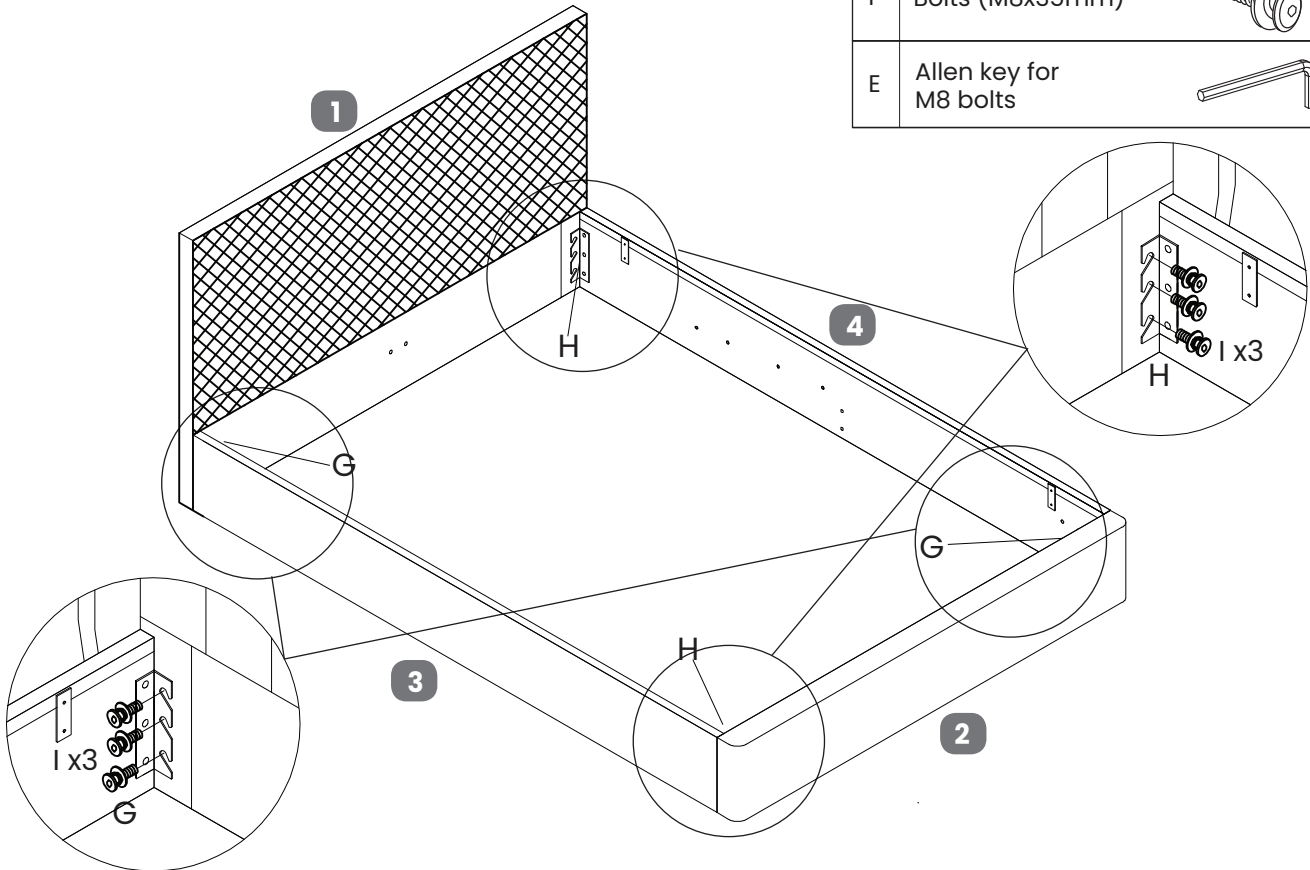

**Step 3:**

I	Bolts (M8x35mm)		12 pcs
E	Allen key for M8 bolts		1 pc



**Step 4:**

F	'L' shape bracket		Double & King 2 pcs
			Super King 4 pcs

B	Bolts (M6x20mm)		Double & King 4 pcs
			Super King 8 pcs
D	Allen key for M6 bolts		1 pc

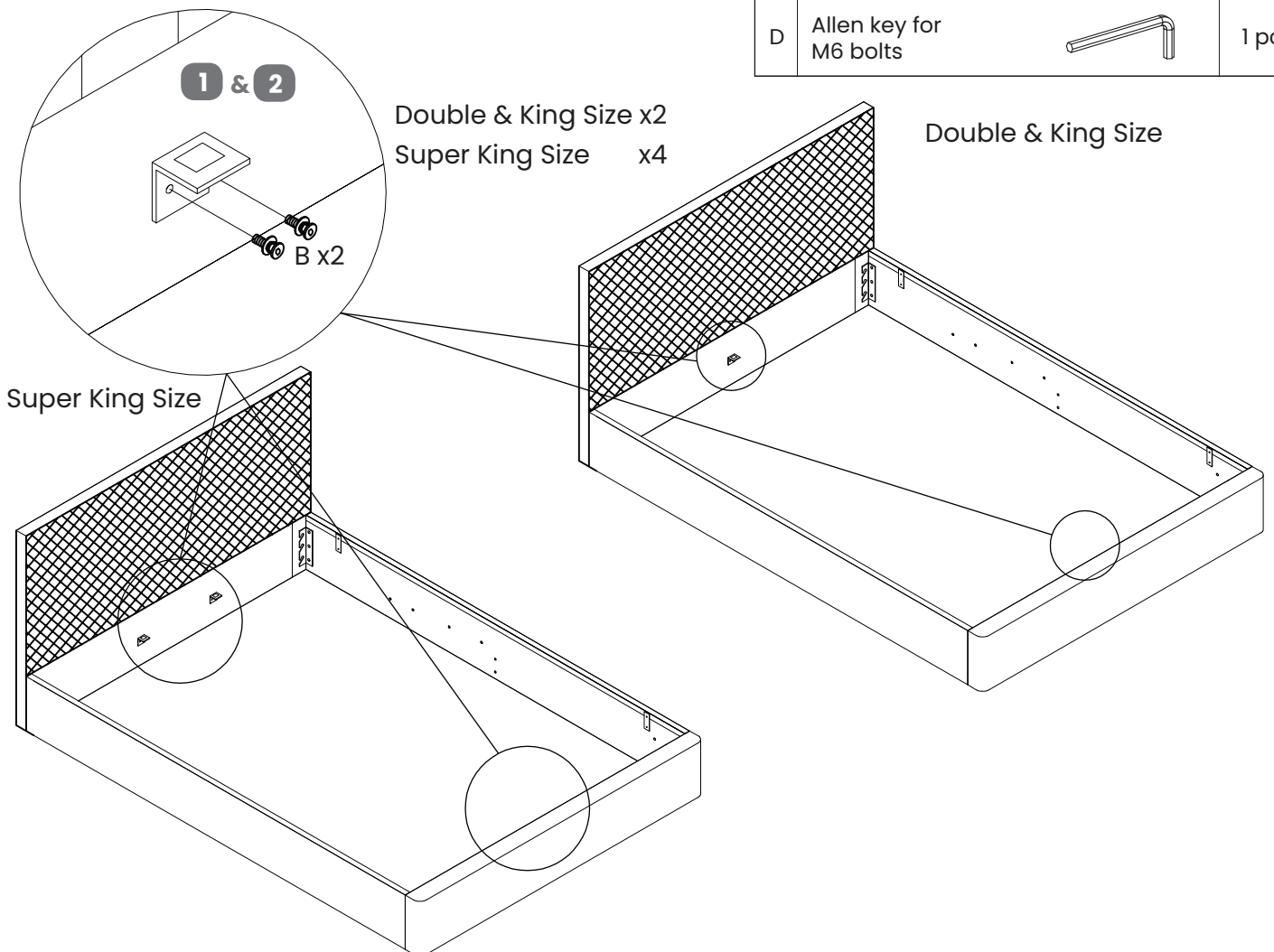



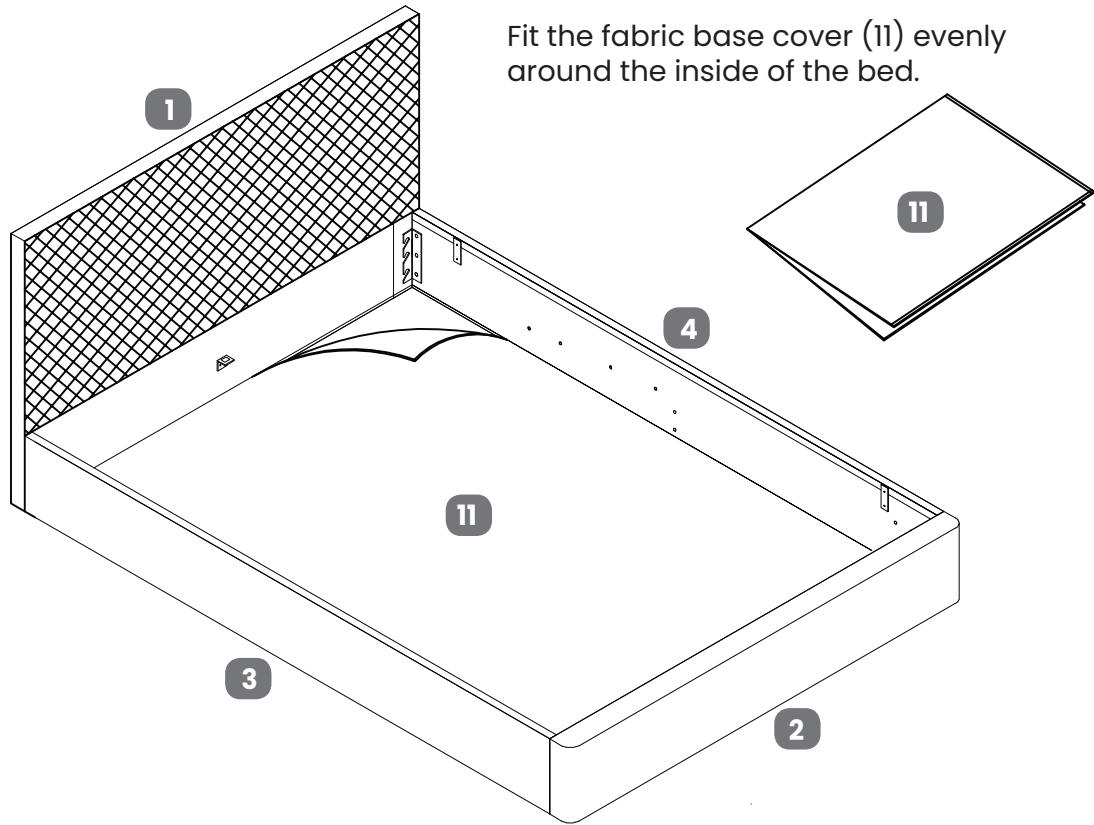

**Step 5:**

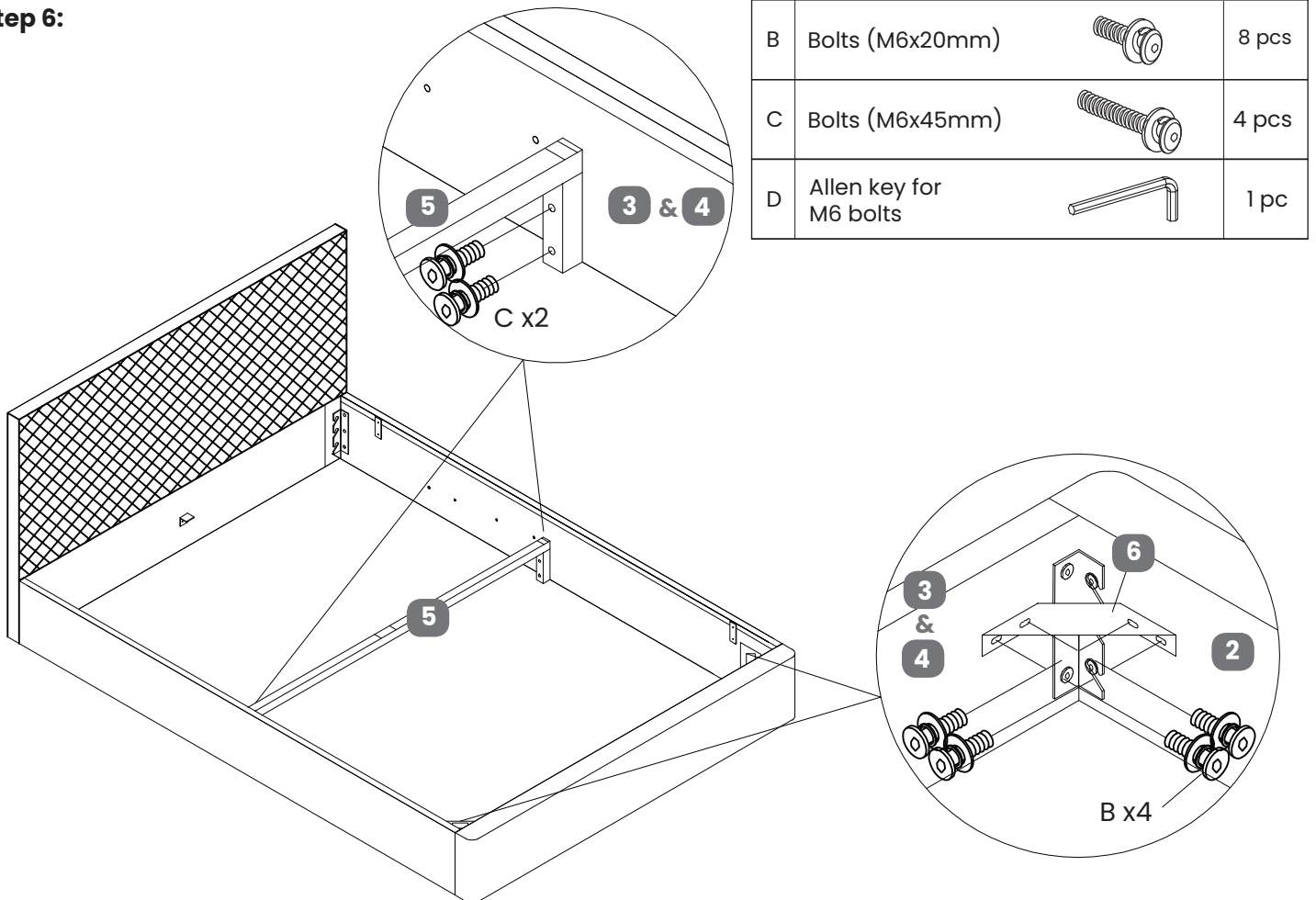

Fit the fabric base cover (11) evenly around the inside of the bed.

**Step 6:**



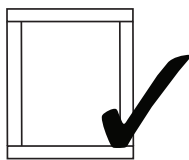
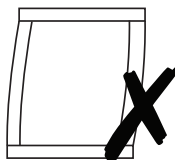

B	Bolts (M6x20mm)		8 pcs
C	Bolts (M6x45mm)		4 pcs
D	Allen key for M6 bolts		1 pc

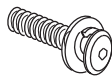

Make certain the bed is squared up as shown in the diagram then tighten all bed assembly bolts 100%.

**Step 7:**

I	Bolts (M8x35mm)		8 pcs
E	Allen key for M8 bolts		1 pc

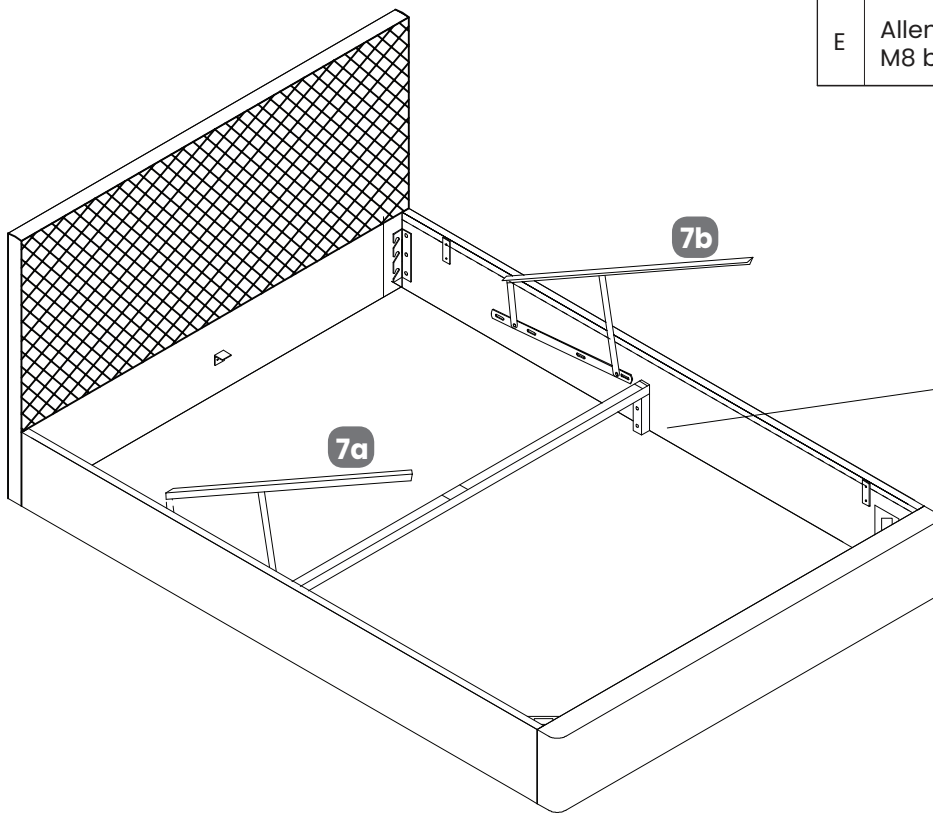

**Step 8:**

A	Bolts (M8x20mm)		4 pcs
---	-----------------	--	-------

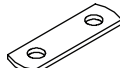
E	Allen key for M8 bolts		1 pc
M	Metal Connection Plate		2 pcs

**i) Carefully open the frame.**

Double & King Size

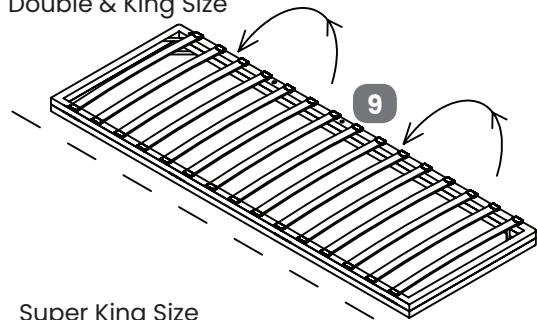

Super King Size

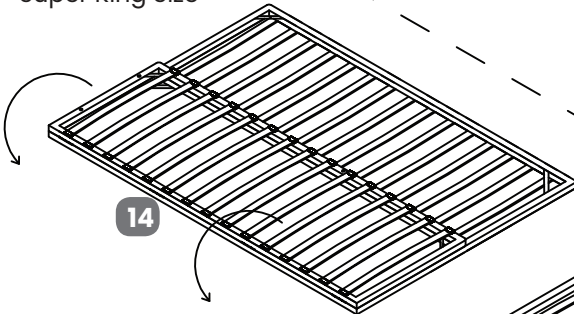



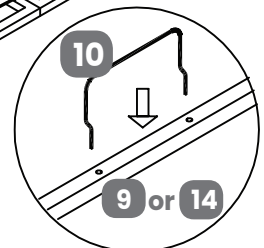
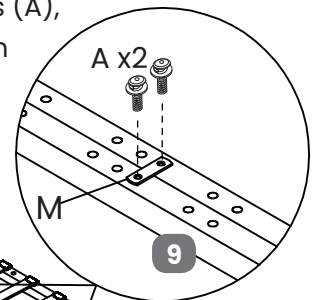

**ii) To top of slat frame, fit two connection plates (M). Using four sets of bolts (A), screw into the threaded inserts on top of the frame.**



**iii) Push x2 Mattress Stoppers (10) into metal frame, they should go all the way through the upper & lower metal sections.**

**Step 9:**

K	Spring Washer for M8 bolts		6 pcs
J	Flat Washer for M8 bolts		12 pcs
E	Allen Key for M8 bolts		1 pc

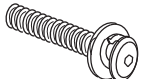
N	Flanged M8 lock-nuts for gas-lift piston		10 pcs
O	Spanner for flanged M8 lock-nuts		1 pc
P	Bolts (M8x45mm)		6 pcs

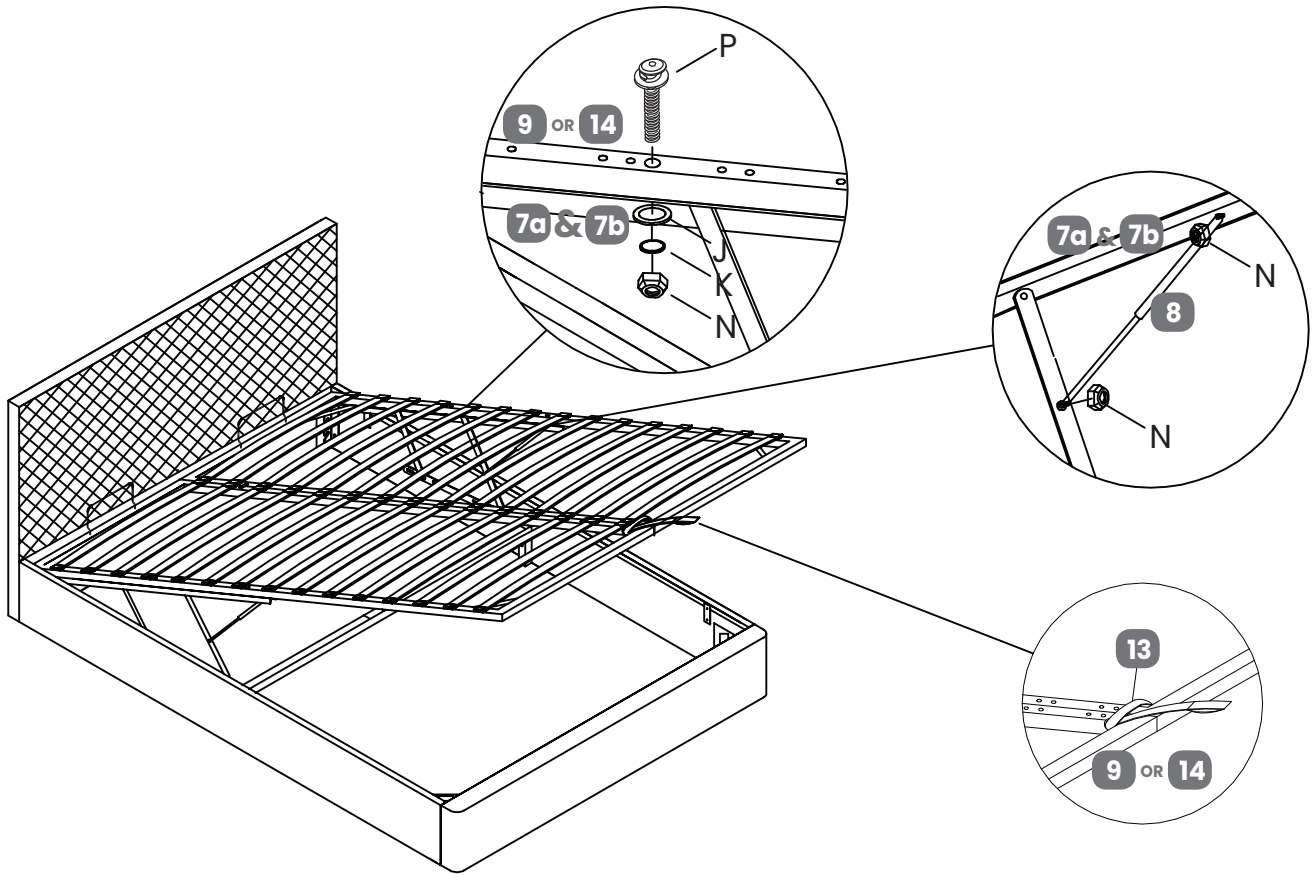

**Step 10:**

**WARNING: ONLY USE THE HANDLE TO LIFT & LOWER THE BED FRAME TO AVOID TRAPPING FINGERS!**

**TO AVOID ACCIDENTS**  
TO ACCESS THE STORAGE AREA THE OTTOMAN FRAME **MUST BE FULLY OPENED** AND THEN **FULLY CLOSED** AFTERWARDS

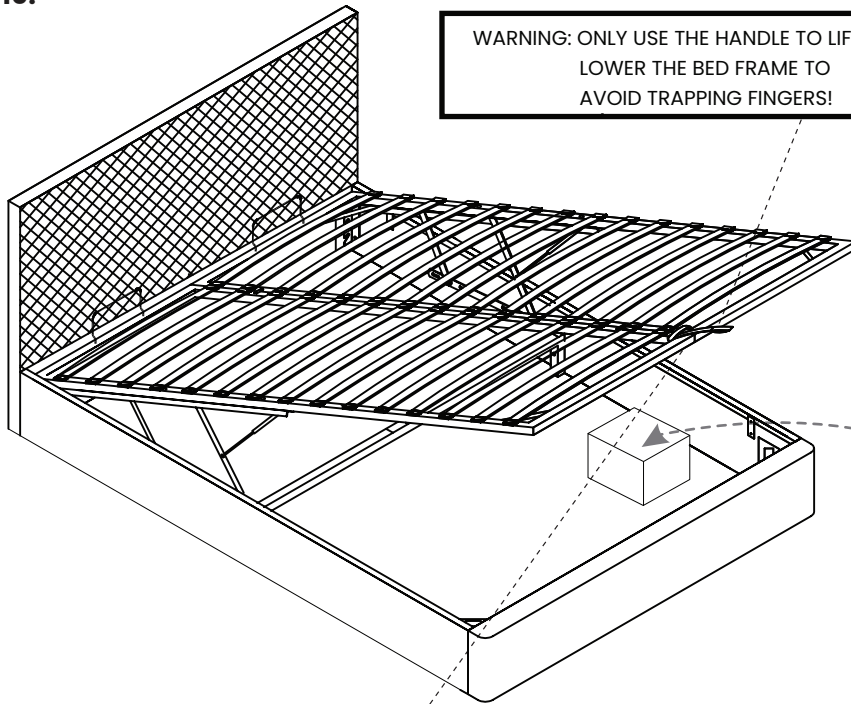

Note: Be very careful what you store under the bed - the top of an item, like a suitcase or a box, must not touch the slats or they may be damaged. Maximum storage height is 210mm.

**SAFETY WARNING**  
PLEASE DO NOT ALLOW CHILDREN OR PETS INSIDE THE STORAGE AREA.

**SAFETY WARNING**  
PLEASE BE CAREFUL WHEN LIFTING. ONLY LIFT WITH MATTRESS ON TOP. TO BE OPERATED BY ADULTS ONLY.



## Technical Specifications

### Overall Dimensions (LWH mm)

Double: 2080 x 1430 x 1230  
King: 2180 x 1580 x 1230  
Super King: 2180 x 1880 x 1230

### Internal Dimensions (LWH mm)

Double: 1930 x 1380 x 210  
King: 2030 x 1530 x 210  
Super King: 2030 x 1830 x 210

### Distance between slats (mm)

Double: 72  
King & Super King: 70

### Ottoman Piston Strength

Double & King: 800N  
Super King: 900N

### Slat Dimension (mm)

Double: 670 x 53 x 9  
King: 745 x 53 x 9  
Super King: 595 x 53 x 9

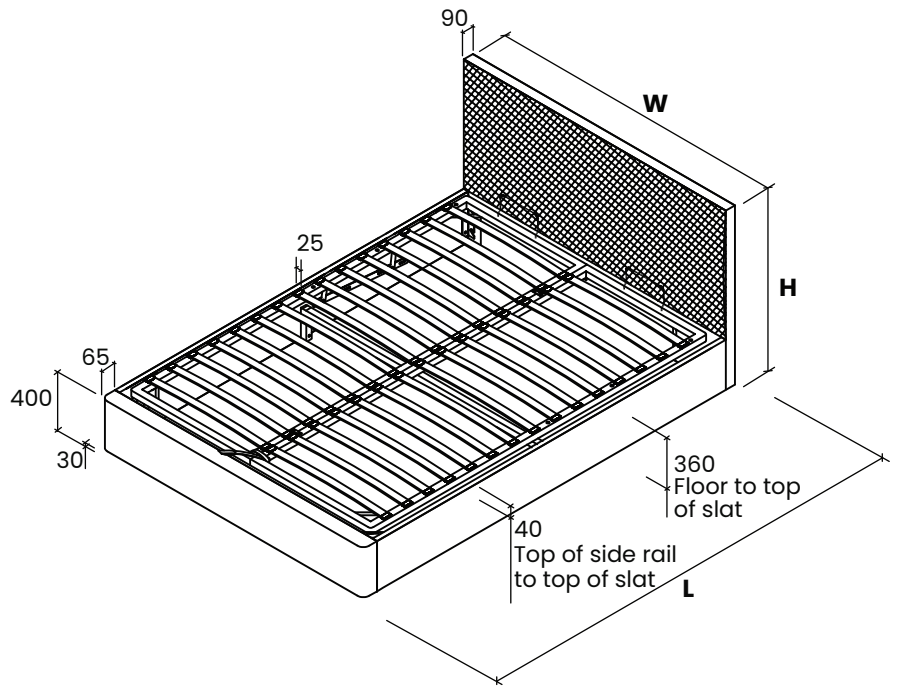

Please dispose of all packaging safely.

## General Care & Maintenance

Wipe clean with a slightly damp cloth.  
Avoid the use of all household cleaners and abrasives.

Periodically check all screw & fixings to ensure they are secure.

When moving your product, carefully lift into place. Never drag or push the product across the floor as this will cause damage to the joints. If the product is used on hard flooring, such as wood or laminated floor, you must place some protection under the legs to stop the product from moving. If this is not adhered to, it could result in failure to the product that will invalidate the warranty.

For more information on cleaning and product care visit:  
<https://www.happybeds.co.uk/help-and-advice>

## Notes

In the unlikely event that you have problems putting this product together or have damaged or missing parts, please contact us by visiting:  
<https://www.happybeds.co.uk/customer-service>