

Assembly Instructions

Important before assembly:

Read these instructions carefully before assembling or using the product.

Please check the contents of the boxes before attempting to assemble this product. The instructions will have a checklist of parts and fittings.

Assemble the product as close to its intended final location/room as possible.

Health & Safety:

This product or some parts of this product will be heavy. Please use an assistant when lifting.

Please keep small parts out of reach of children.

Always use on a level, even surface.

DO NOT jump on the product or any of its parts.

DO NOT use this product if any parts are missing, damaged or worn.

DO NOT use this product unless all fixings are secured.

Further instructions are on the following pages.

Please keep these instructions for future reference.



This product or some parts of this product will be heavy. Please use an assistant when lifting.



Never drag or push the pieces across a hard or stone floor as this will cause damage to the joints. Use a carpet or a rug for extra care.



If you have problems assembling or have damaged or missing pieces, please contact our customer services (details at the back of these instructions)

PARTS LIST

1.

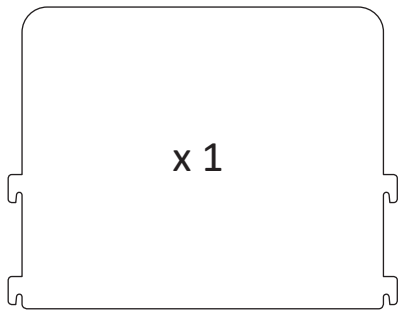

2.

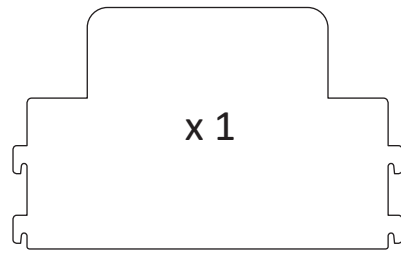

3.

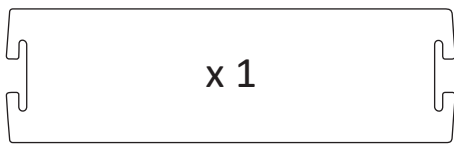

4.

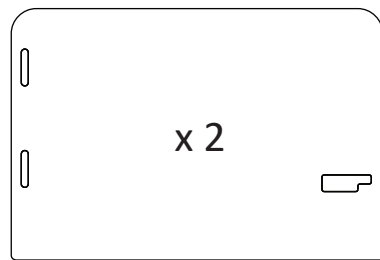

5.

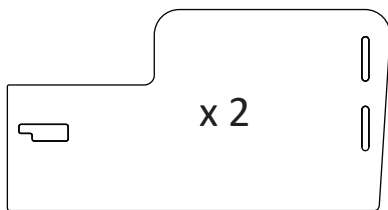

6.

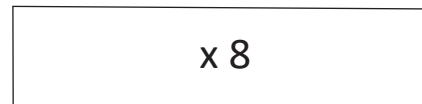

7.

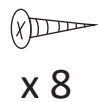

8.

1. Headboa

3. Centre Suppo

5. Front Side Pan

7. Scrc

2. Footboa

4. Back Side Pan

6. Sla

8.

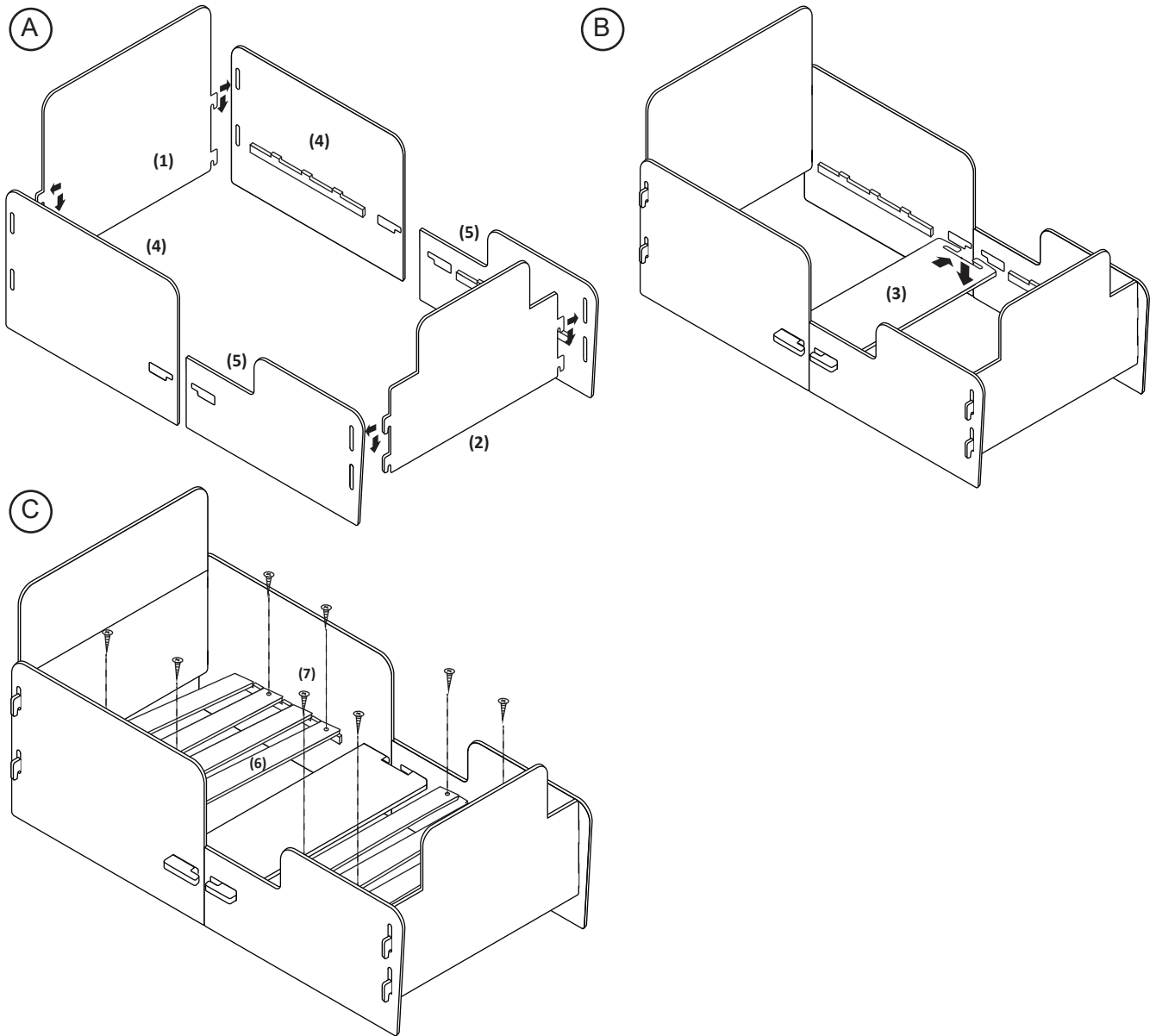

- A. Take the headboard (1) and slot into the back side panels (4). Do the same with the footboard (2) slot into the front side panels (5).
- B. Pull the front / back side panels (5 + 4) together, then insert the centre support (3) to the holes in the side on oneside, then repeat for the other side.
- C. Put slats (6) in place on the side panels (4 + 5), take the screws (7) and put into the slats (6) with screw driver (not supplied).

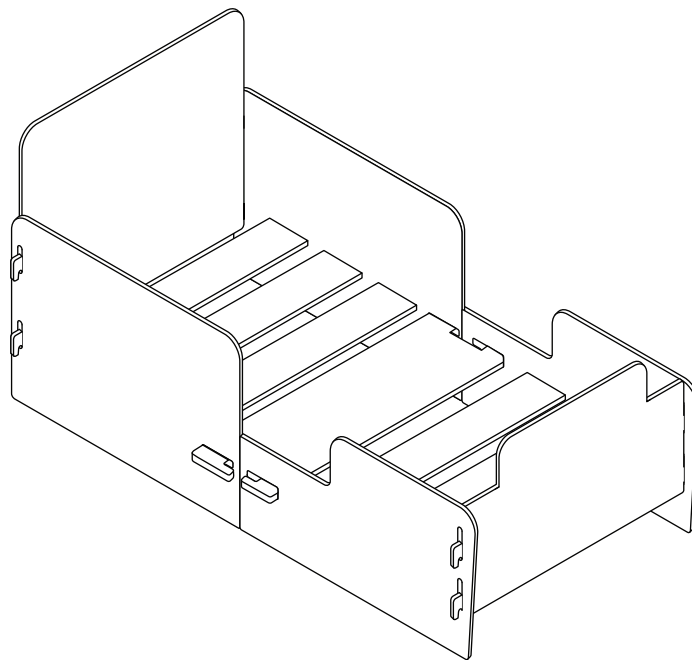

The unit is now complete, please read the user guide notes to maintain the unit to its highest standard.

Please dispose of all packaging safely.

General Care & Maintenance

Wipe clean with a slightly damp cloth.
Avoid the use of all household cleaners and abrasives.

Periodically check all screw & fixings to ensure they are secure.

When moving your product, carefully lift into place. Never drag or push the product across the floor as this will cause damage to the joints. If the product is used on hard flooring, such as wood or laminated floor, you must place some protection under the legs to stop the product from moving. If this is not adhered to, it could result in failure to the product that will invalidate the warranty.

For more information on cleaning and product care visit:
<https://www.happybeds.co.uk/help-and-advice>

Notes

In the unlikely event that you have problems putting this product together or have damaged or missing parts, please contact us by visiting:
<https://www.happybeds.co.uk/customer-service>

USER GUIDE

Thank you for choosing a KIDSAW product. Please take a little time to read the important safety notes detailed below. This will ensure many years of happy, safe use.

SAFETY: TAKE NOTE

- Keep this product away from fire and direct heat sources.
- Only use spares approved by KIDSAW.
- Always empty the unit before dismantling.
- Adult assembly required.

CARE & MAINTENANCE

- All surfaces should be wiped over using a damp cloth to clean.
- Never clean with abrasive, ammonia based, bleach or spirit type cleaner

**IMPORTANT
KEEP FOR FUTURE REFERENCE & READ CAREFULLY**

TRACTOR JUNIOR BED

Follow us on
facebook 

www.facebook.com/kidsaw

INSTRUCTIONS

KIDSAW[®]
MAKES FURNITURE CHILDS' PLAY

Kidsaw Ltd
Tel: +44 (0)116 2519551 Email: support@kidsaw.co.uk
www.kidsaw.co.uk