



Assembly Instructions

Onyx Metal Bed



Important before assembly:

Read these instructions carefully before assembling or using the product.

Please check the contents of the boxes before attempting to assemble this product. The instructions will have a checklist of parts and fittings.

It would be sensible to lay a rug or a carpet on the floor where you intend to assemble the product, to void scratches and damaging the product or the floor.

Assemble the product as close to its intended final location/room as possible.

Do NOT use any power tools as this may damage the frame.

Health & Safety:

This product or some parts of this product will be heavy. Please use an assistant when lifting.

DO NOT jump on the product or any of its parts.

DO NOT use this product if any parts are missing, damaged or worn.

DO NOT use this product unless all fixings are secured.

Please keep small parts out of reach of children.

Always use on a level, even surface.

Please keep these instructions for future reference.

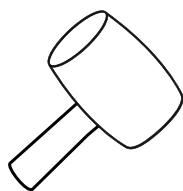

(Not metal)

These tools are not necessary, but may help to assemble certain parts of the product.

Do NOT use any power tools as this may damage the frame.

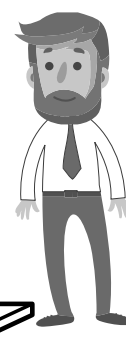
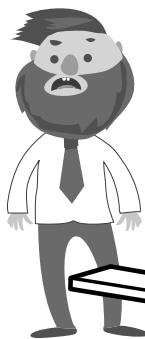

This product or some parts of this product will be heavy. Please use an assistant when lifting.

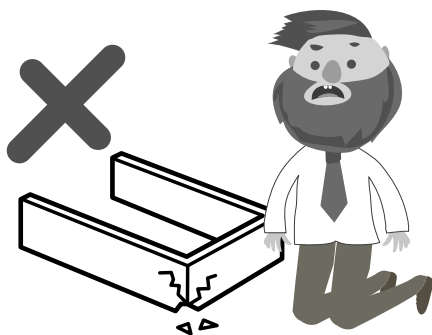

Never drag or push the pieces across a hard or stone floor as this will cause damage to the joints. Use a carpet or a rug for extra care.

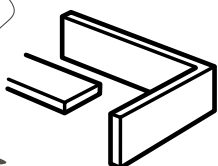
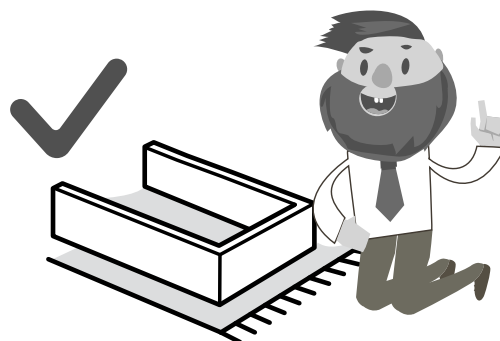

If you have problems assembling or have damaged or missing pieces, please contact us by visiting:

<https://www.happybeds.co.uk/customer-service>

HARDWARE

A

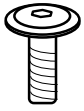

4x

B



4x

C

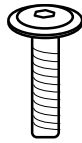

8x

D

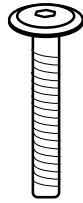

4x

E

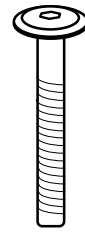

4x

F



8x

[*A & B already attached
to Centre Leg Part 9*]

G



8x

H



8x

I



1x

J



1x

K

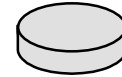

6x

PARTS

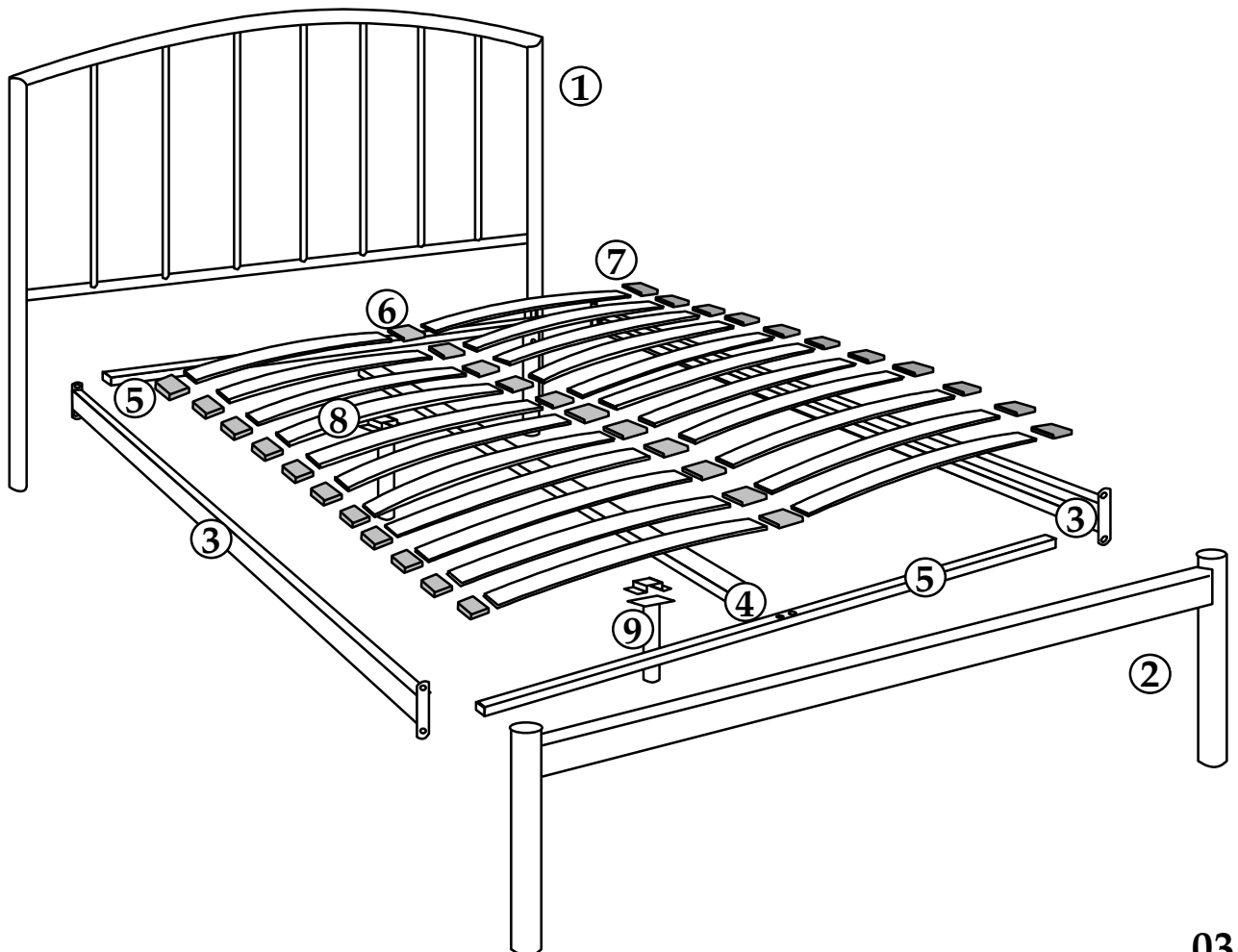

Safety Advice

Please take the time to carefully read through the whole of these instructions before you commence.

Keep these instructions for future reference.

Unpack, inspect and check off all of the contents.

Please dispose of all packaging safely.

Small component parts could choke a child if swallowed.

We strongly recommend that you keep children well away from the work area.

It would be sensible to lay a sheet or blanket on the floor where you intend to work to avoid scratching this product and to protect your floor.

This product is heavy. Take extreme care when lifting to avoid personal injury or damage to the product.

Assemble the product as close to its intended final position in the room as possible.

HANDY HINT: If you keep the hardware in a bowl during assembly you will be less likely to lose them.

1

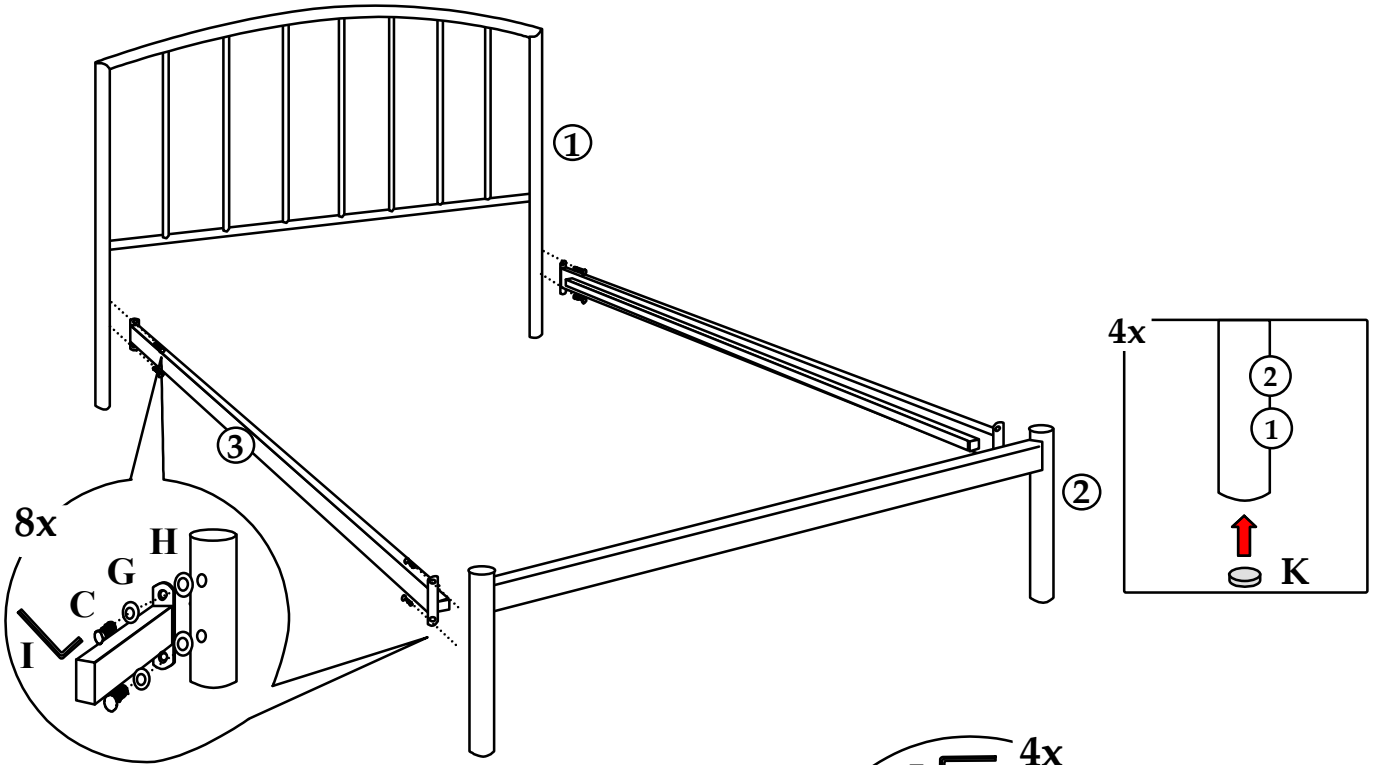

2

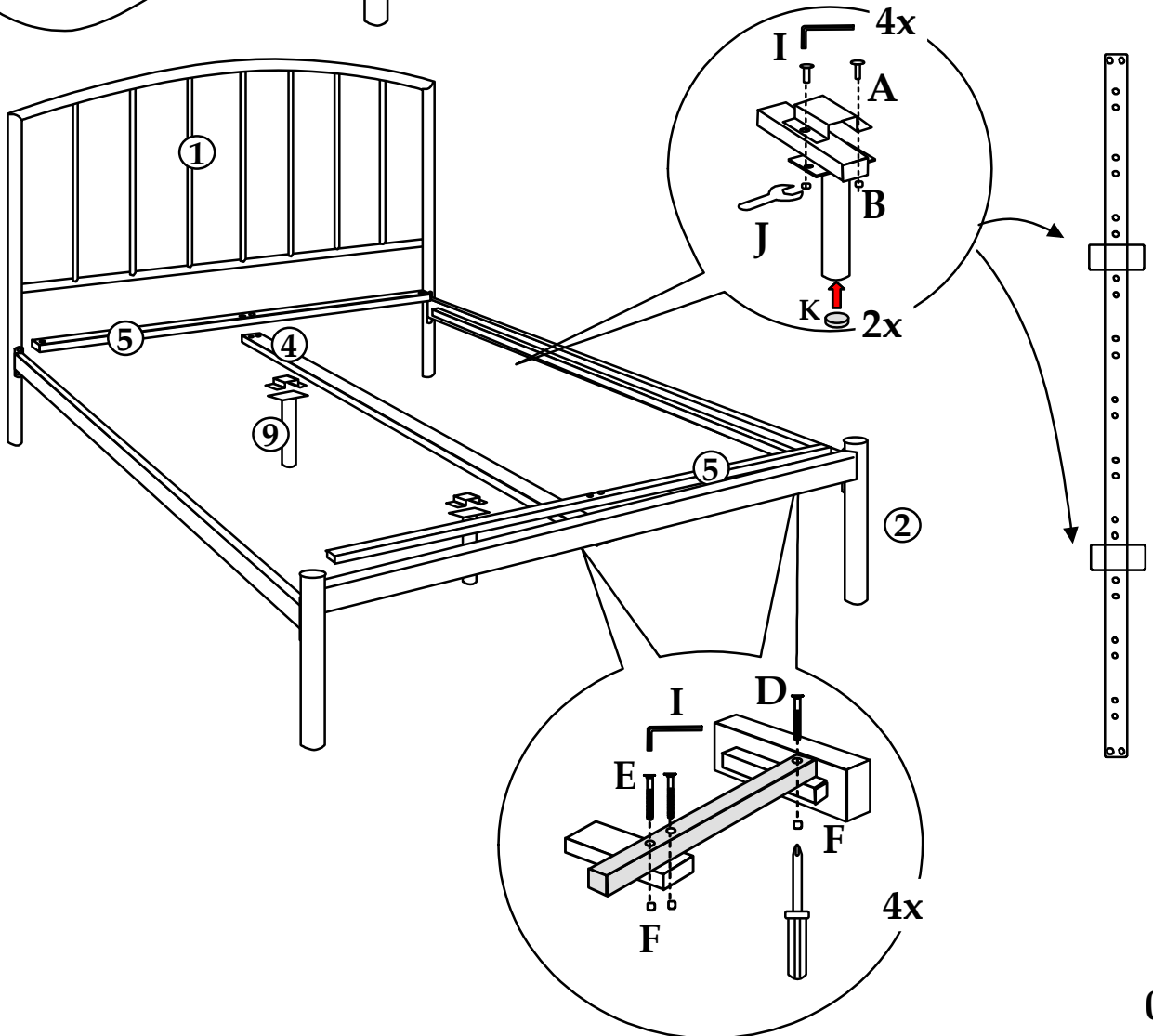

3

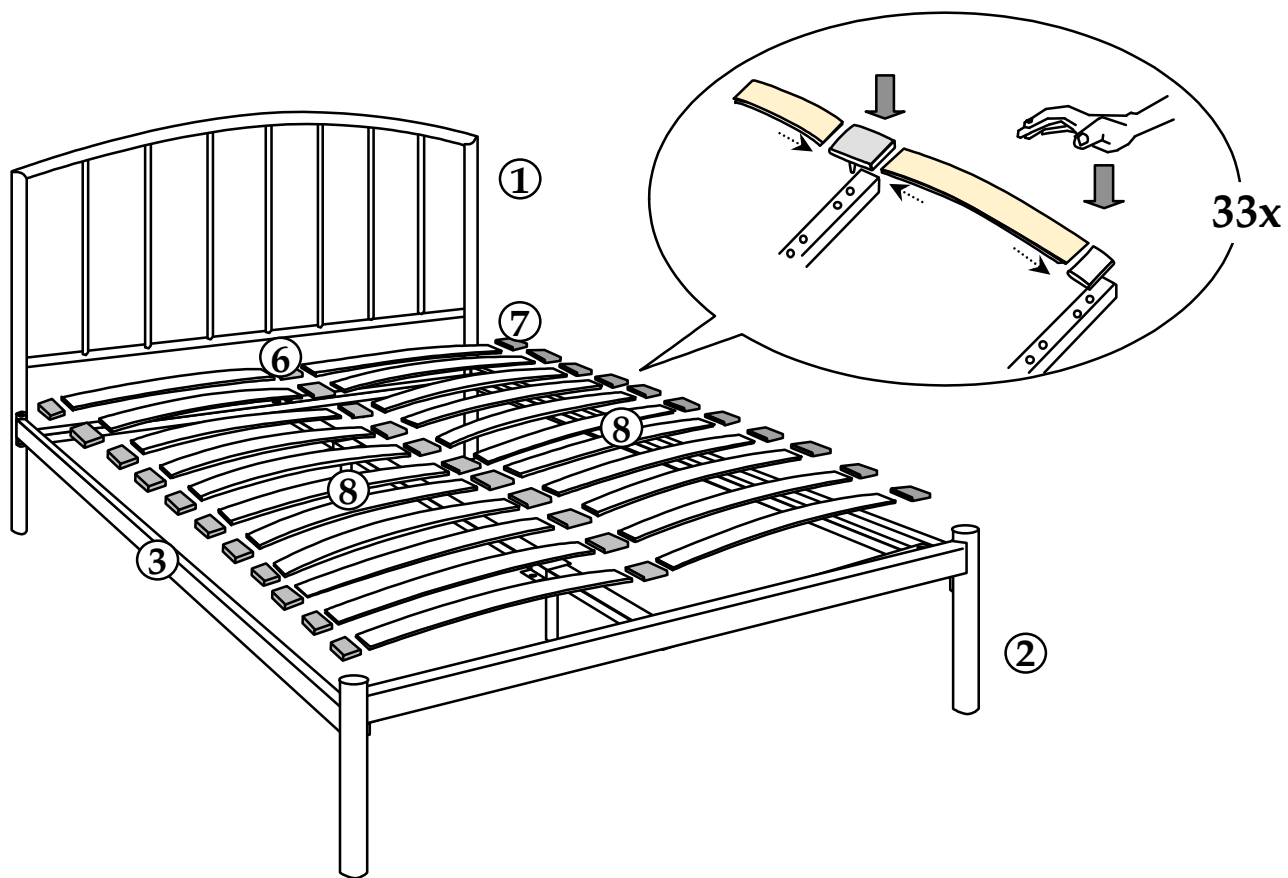

Urgent Warning

When correctly adjusted the centre support legs on this product should be raised by 5mm from the floor with the added weight of the mattress and bedding.

This bed may fail if it is used on a wooden floor WITHOUT the use of non slip pads on all support legs and bed posts.

If the bed is to be moved, carefully lift the product rather than dragging to ensure that the centre legs do not become twisted and buckle.

Please dispose of all packaging safely.

General Care & Maintenance

Wipe clean with a slightly damp cloth.
Avoid the use of all household cleaners and abrasives.

Periodically check all screw & fixings to ensure they are secure.
When moving your product, carefully lift into place. Never drag or push the pieces across the floor as this will cause damage to the joints and could result in failure to the product that will invalidate the warranty.

For more information on cleaning and product care visit:
<https://www.happybeds.co.uk/help-and-advice>

Notes

We've tried to make this product as easy to assemble as possible. In the unlikely event that you have problems putting it together or have damaged or missing pieces, please contact us by visiting:
<https://www.happybeds.co.uk/customer-service>



www.happybeds.co.uk

